

Address: Building 2th, Xinan Second Industrial Zone, Shenzhen, Guangdong, China. 518100  
 Website: www.sunul.com E-mail: Inquiry@SunuL.com Phone: +86 755 3394 2898

### Metal Housing Type Monitor

#### 8" Metal Monitor (4:3)

Model:	MM-0848
Panel:	8 inch
Resolution:	1024x768
Brightness:	350 nits
Contrast:	800:1
Angle:	80/75/80/75
Dimension:	187x144x35 mm
Language:	En,De,Fr,Sp,Ru,Pt,It
Inputs:	VGA/AV/BNC/HDMI/USB x1
Touch:	Options capacitive or resistive
Power:	12V, 1.5A
Mount:	VESA,Panel,Desktop Options
N.W:	1.5KG
G.W:	2.0KG

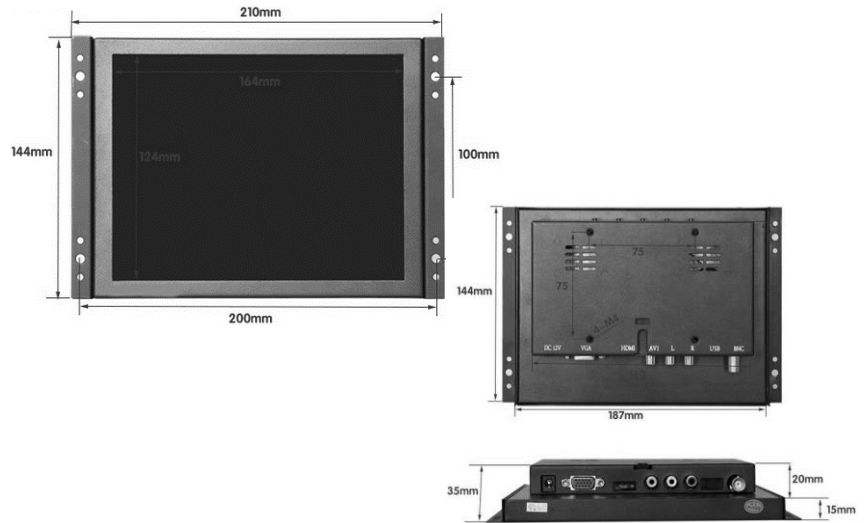

#### 9.7" Metal Monitor (4:3)

Model:	MM-0948
Panel:	9.7 inch
Resolution:	1024x768
Brightness:	350 nits
Contrast:	800:1
Angle:	80/75/80/75
Dimension:	250x184x35 mm
Language:	En,De,Fr,Sp,Ru,Pt,It
Inputs:	VGA/AV/BNC/HDMI/USB x1
Touch:	Options capacitive or resistive
Power:	12V, 1.5A
Mount:	VESA,Panel,Desktop Options
N.W:	1.8KG
G.W:	2.6KG

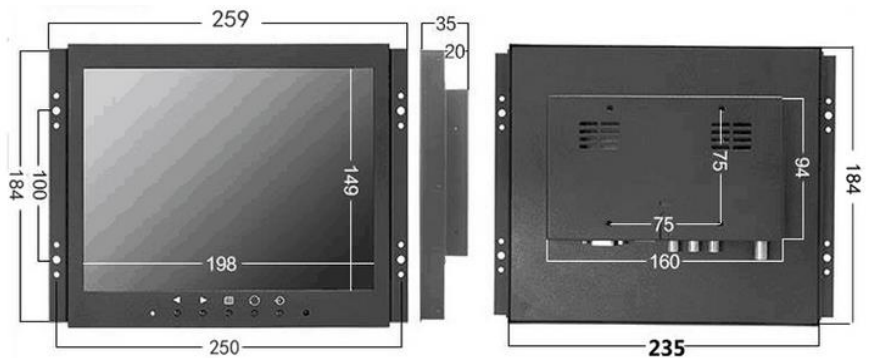

#### 10" Metal Monitor (4:3)

Model:	MM-1000
Panel:	10 inch
Resolution:	800x600
Brightness:	350 nits
Contrast:	800:1
Angle:	80/75/80/75
Dimension:	248x178x49 mm
Language:	En,De,Fr,Sp,Ru,Pt,It
Inputs:	VGA/AV/BNC/HDMI/USB x1

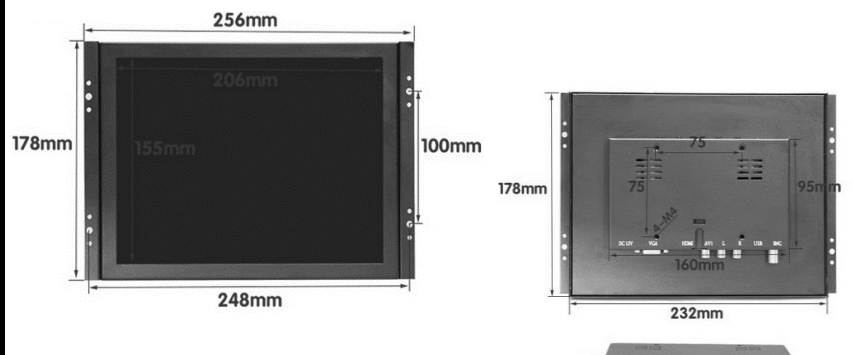

Touch:	Options capacitive or resistive
Power:	12V, 2A
Mount:	VESA,Panel,Desktop Options
N.W:	3KG
G.W:	3.5KG



### 10.1" Metal Monitor (16:9)

Model:	MM-1010 (MM-101H)
Panel:	10.1 inch
Resolution:	1280x800 (1920x1200)
Brightness:	300 nits
Contrast:	800:1
Angle:	80/75/80/75
Dimension:	245x167x35 mm
Language:	En,De,Fr,Sp,Ru,Pt,It
Inputs:	VGA/AV/BNC/HDMI/USB x1
Touch:	Options capacitive or resistive
Power:	12V, 2A
Mount:	VESA,Panel,Desktop Options
N.W:	1.9KG
G.W:	2.8KG

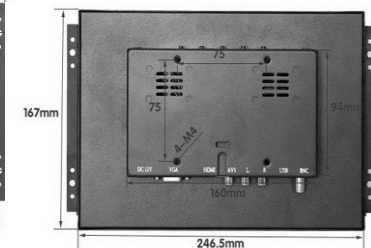
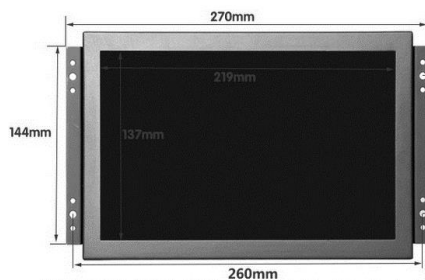

### 11.6" Metal Monitor (16:9)

Model:	MM-1160
Panel:	11.6 inch
Resolution:	1920X1080
Brightness:	350 nits
Contrast:	800:1
Angle:	80/75/80/75
Dimension:	281x168x45 mm
Language:	En,De,Fr,Sp,Ru,Pt,It
Inputs:	VGA/AV/BNC/HDMI/USB x1
Touch:	Options capacitive or resistive
Power:	12V, 2A
Mount:	VESA,Panel,Desktop Options
N.W:	2.0KG
G.W:	2.8KG

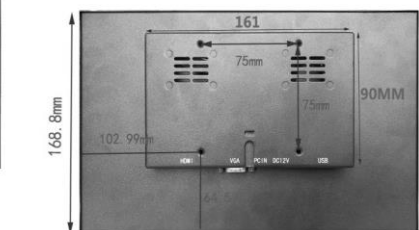
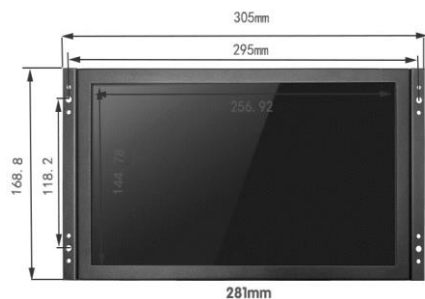

### 12" Metal Monitor (4:3)

Model:	MM-1248
Panel:	12 inch
Resolution:	1024x768
Brightness:	350 nits
Contrast:	800:1
Angle:	80/75/80/75
Dimension:	286x224x41 mm
Language:	En,De,Fr,Sp,Ru,Pt,It
Inputs:	VGA/AV/BNC/HDMI/USB x1
Touch:	Options capacitive or resistive
Power:	12V, 2A

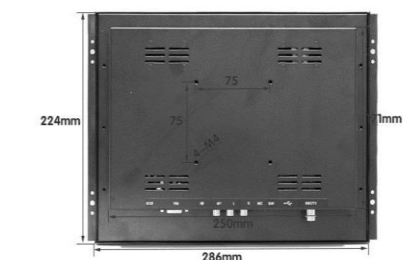
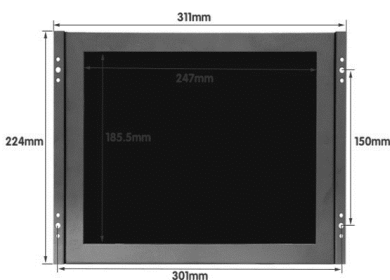

Mount:	VESA,Panel,Desktop Options
N.W:	3.0KG
G.W:	3.8KG

### 12" Metal Monitor (16:9)

Model:	MM-1200
Panel:	12 inch
Resolution:	1920x1080
Brightness:	350 nits
Contrast:	800:1
Angle:	80/75/80/75
Dimension:	281x168x45 mm
Language:	En,De,Fr,Sp,Ru,Pt,It
Inputs:	VGA/AV/BNC/HDMI/USB x1
Touch:	Options capacitive or resistive
Power:	12V, 3A
Mount:	VESA,Panel,Desktop Options
N.W:	4.3KG
G.W:	5.5KG

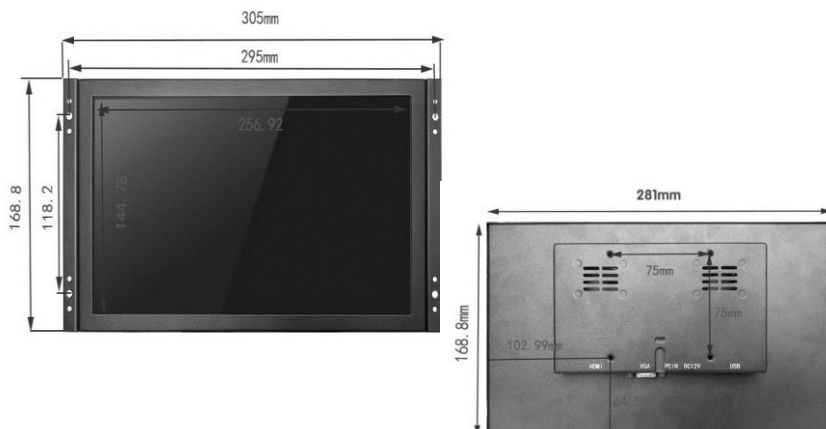

### 13.3" Metal Monitor (16:9)

Model:	MM-1330
Panel:	13.3 inch
Resolution:	1920X1080
Brightness:	350 nits
Contrast:	800:1
Angle:	80/75/80/75
Dimension:	332x194x50 mm
Language:	En,De,Fr,Sp,Ru,Pt,It
Inputs:	VGA/AV/BNC/HDMI/USB x1
Touch:	Options capacitive or resistive
Power:	12V, 3A
Mount:	VESA,Panel,Desktop Options
N.W:	2.5KG
G.W:	3.2KG

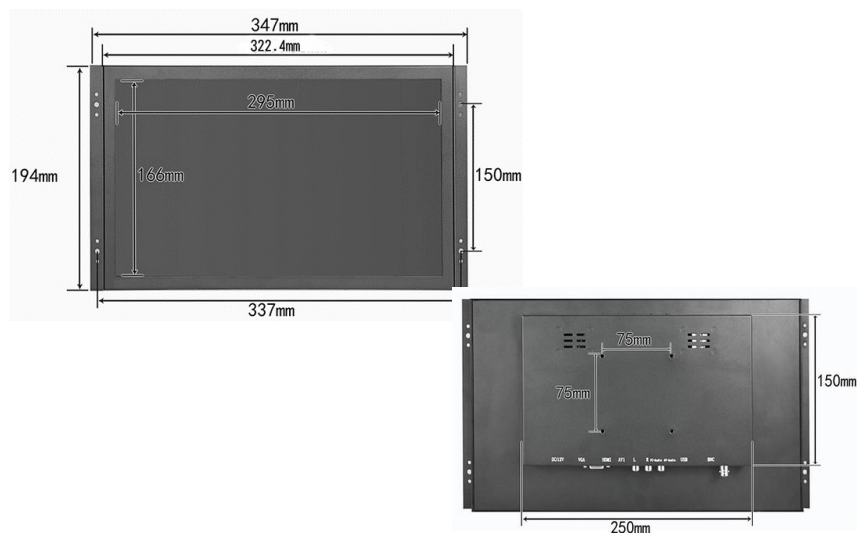

### 14" Metal Monitor (16:9)

Model:	MM-1400
Panel:	14 inch
Resolution:	1920x1080
Brightness:	350 nits
Contrast:	800:1
Angle:	80/75/80/75
Dimension:	340x212x50 mm
Language:	En,De,Fr,Sp,Ru,Pt,It
Inputs:	VGA/AV/BNC/HDMI/USB x1
Touch:	Options capacitive or resistive
Power:	12V, 3A
Mount:	VESA,Panel,Desktop Options
N.W:	2.8KG

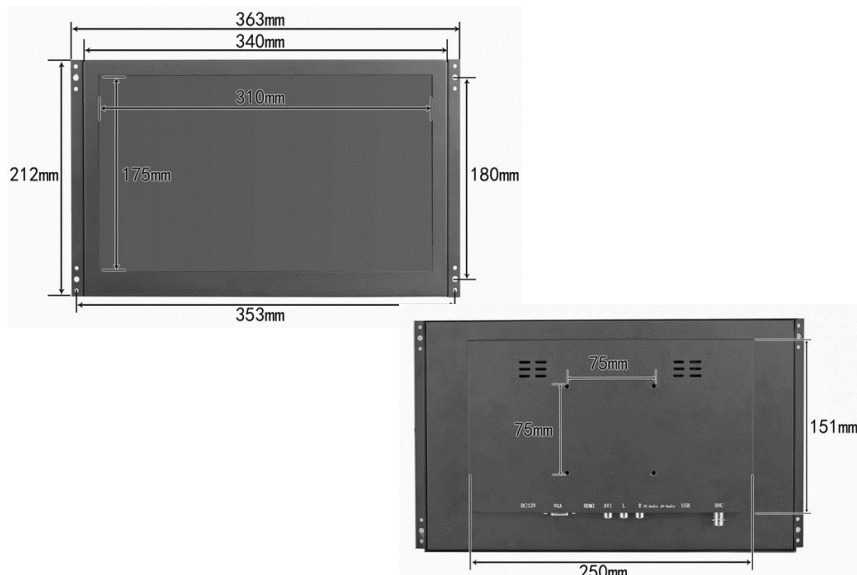

G.W:	3.5KG
<b>15" Metal Monitor (4:3)</b>	
Model:	MM-1548
Panel:	15 inch
Resolution:	1024x768
Brightness:	350 nits
Contrast:	800:1
Angle:	80/75/80/75
Dimension:	333x258x45 mm
Language:	En,De,Fr,Sp,Ru,Pt,It
Inputs:	VGA/AV/BNC/HDMI/USB x1
Touch:	Options capacitive or resistive
Power:	12V, 3A
Mount:	VESA,Panel,Desktop Options
N.W:	3.6KG
G.W:	4.5KG

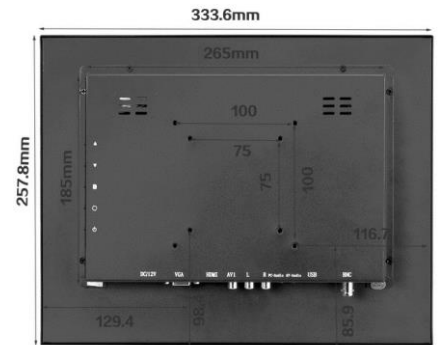

<b>15.6" Metal Monitor (16:9)</b>	
Model:	MM-1560
Panel:	15.6 inch
Resolution:	1920X1080
Brightness:	350 nits
Contrast:	800:1
Angle:	80/75/80/75
Dimension:	373x195x45mm
Language:	En,De,Fr,Sp,Ru,Pt,It
Inputs:	VGA/AV/BNC/HDMI/USB x1
Touch:	Options capacitive or resistive
Power:	12V, 3A
Mount:	VESA,Panel,Desktop Options
N.W:	5KG
G.W:	5.8KG

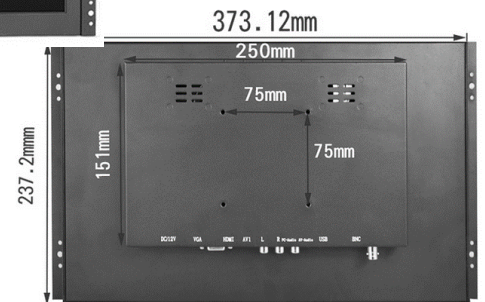
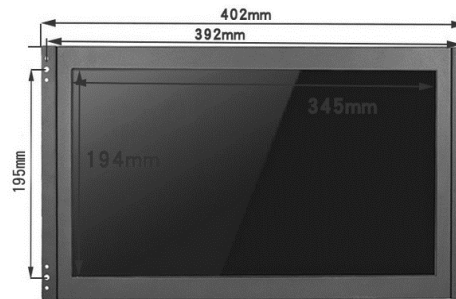

<b>17" Metal Monitor (4:3)</b>	
Model:	MM-1704
Panel:	17 inch
Resolution:	1280x1024
Brightness:	350 nits
Contrast:	800:1
Angle:	80/75/80/75
Dimension:	365x304x55 mm
Language:	En,De,Fr,Sp,Ru,Pt,It
Inputs:	VGA/AV/BNC/HDMI/USB x1
Touch:	Options capacitive or resistive
Power:	12V, 3A
Mount:	VESA,Panel,Desktop Options
N.W:	5.0KG
G.W:	6.5KG

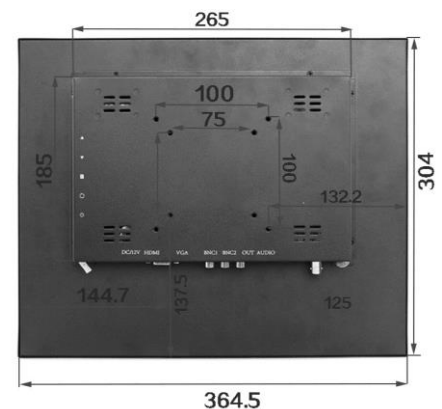
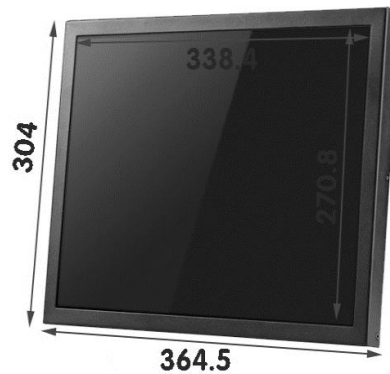

<b>17.3" Metal Monitor (16:9)</b>	
-----------------------------------	--

Model:	MM-1730
Panel:	17.3 inch
Resolution:	1920x1080
Brightness:	350 nits
Contrast:	800:1
Angle:	80/75/80/75
Dimension:	410x252.6x50 mm
Language:	En,De,Fr,Sp,Ru,Pt,It
Inputs:	VGA/AV/BNC/HDMI/USB x1
Touch:	Options capacitive or resistive
Power:	12V, 3A
Mount:	VESA,Panel,Desktop Options
N.W:	6.5KG
G.W:	8.0KG

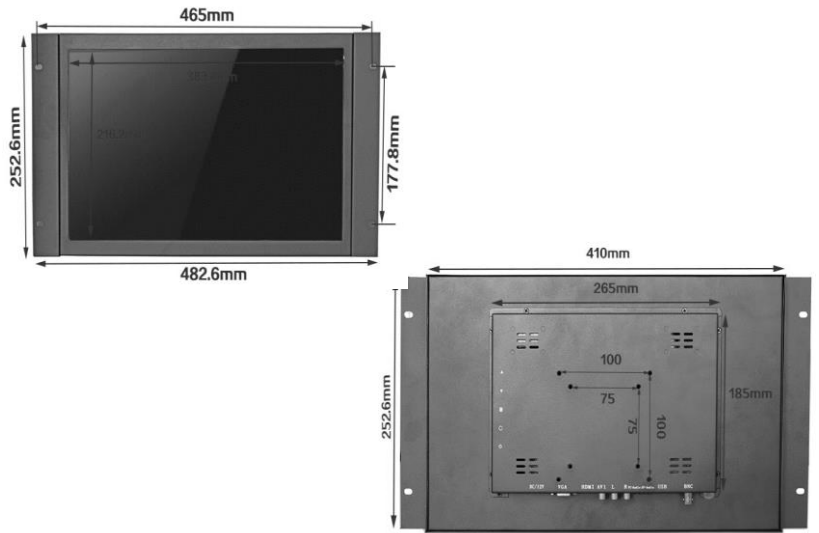

### 19" Metal Monitor (4:3)

Model:	MM-1904
Panel:	19 inch
Resolution:	1280x1024
Brightness:	350 nits
Contrast:	800:1
Angle:	80/75/80/75
Dimension:	400x327x50 mm
Language:	En,De,Fr,Sp,Ru,Pt,It
Inputs:	VGA/AV/BNC/HDMI/USB x1
Touch:	Options capacitive or resistive
Power:	12V, 3A
Mount:	VESA,Panel,Desktop Options
N.W:	6.3KG
G.W:	7.5KG

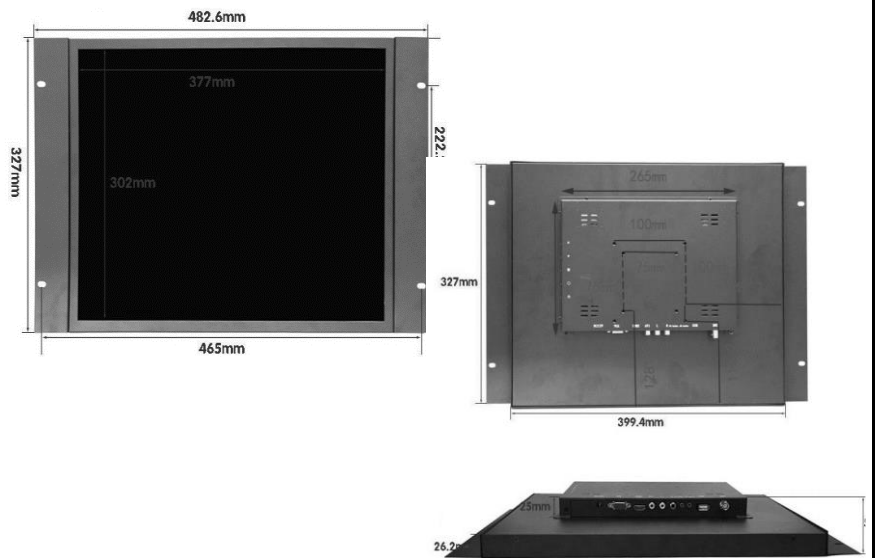

### 19" Metal Monitor (16:9)

Model:	MM-1900
Panel:	19 inch
Resolution:	1440x900
Brightness:	350 nits
Contrast:	800:1
Angle:	80/75/80/75
Dimension:	434x284x55 mm
Language:	En,De,Fr,Sp,Ru,Pt,It
Inputs:	VGA/AV/BNC/HDMI/USB x1
Touch:	Options capacitive or resistive
Power:	12V, 3A
Mount:	VESA,Panel,Desktop Options
N.W:	6.0KG
G.W:	7.0KG

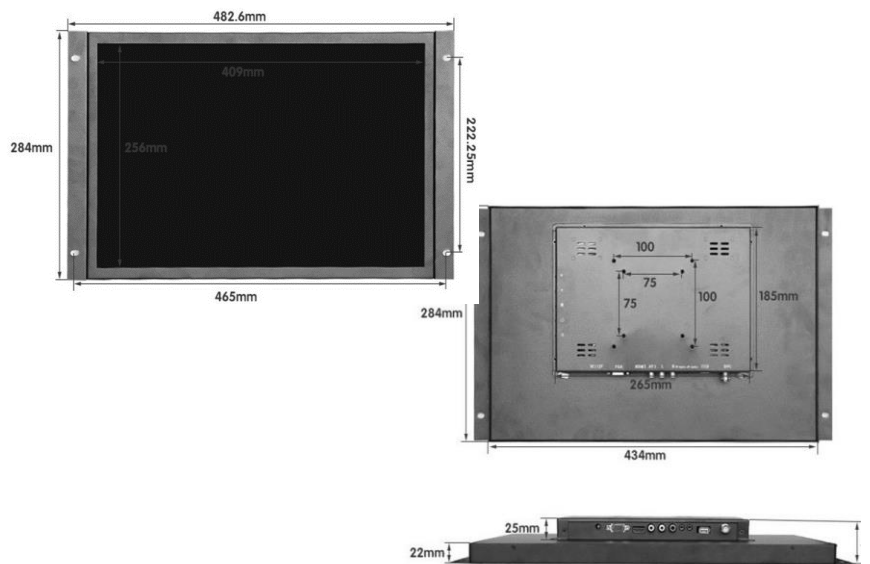

### 21.5" Metal Monitor (16:9)

Model:	MM-21500
Panel:	21.5 inch



Resolution:	1920x1080
Brightness:	350 nits
Contrast:	800:1
Angle:	80/75/80/75
Dimension:	504x298x45 mm
Language:	En,De,Fr,Sp,Ru,Pt,It
Inputs:	VGA/AV/BNC/HDMI/USB x1
Touch:	Options capacitive or resistive
Power:	12V, 3A
Mount:	VESA,Panel,Desktop Options
N.W:	6.8KG
G.W:	8.0KG

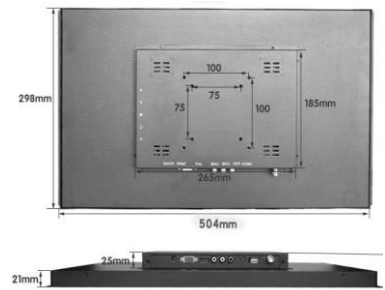

Address: Building 2th, Xinan Second Industrial Zone, Shenzhen, Guangdong, China. 518100

Website: [www.sunul.com](http://www.sunul.com) E-mail: [Inquiry@SunuL.com](mailto:Inquiry@SunuL.com) Phone: +86 755 3394 2898

**SUNUL**

**CUSTOMIZED INDUSTRIAL MONITORS**