

PRODUCT SPECIFICATION

11.0" TN TFT LCD MODULE

MODEL: T110128120-A1TMN-005 Ver:1.2



< ◇ > Preliminary Specification

< ◆ > Finally Specification

CUSTOMER'S APPROVAL	
CUSTOMER :	
SIGNATURE:	DATE:

APPROVED BY	PM REVIEWED	PD REVIEWED	PREPARED BY

Revision History

Revision	Date	Originator	Detail	Remarks
1.0	2018.01.11	ZFY	Initial Release	
1.1	2018.03.22	ZDT	Add LED working life Modify Luminance on TFT Modify many details Modify Outline Drawing	P5 P6 P20-P21 P23
1.2	2018.03.27	ZFY	Add weight Add chromaticity	P4 P6

Table of Contents

No.	Item	Page
1.	General Description	4
2.	Module Parameter	4
3.	Absolute Maximum Ratings	4
4.	DC Characteristics	5
5.	Backlight Characteristic	5
5.1.	Backlight Characteristics	5
5.2.	Backlighting circuit	5
6.	Optical Characteristics	6
6.1.	Optical Characteristics	6
6.2.	Definition of Response Time	6
6.3.	Definition of Contrast Ratio	7
6.4.	Definition of Viewing Angles	7
6.5.	Definition of Color Appearance	8
6.6.	Definition of Surface Luminance, Uniformity and Transmittance	8
7.	Block Diagram and Power Supply	9
8.	Interface Pins Definition	10
9.	Timing Chart	11
9.1.	Input Clock and Data Timing Diagram	11
9.2.	Data Input Format	11
10.	Quality Assurance	13
10.1.	Purpose	13
10.2.	Standard for Quality Test	13
10.3.	Nonconforming Analysis & Disposition	13
10.4.	Agreement Items	13
10.5.	Standard of the Product Visual Inspection	13
10.6.	Inspection Specification	14
10.7.	Classification of Defects	18
10.8.	Identification/marketing criteria	18
10.9.	Packaging	18
11.	Reliability Specification	19
12.	Precautions and Warranty	20
12.1.	Safety	20
12.2.	Handling	20
12.3.	Storage	20
12.4.	Metal Pin (Apply to Products with Metal Pins)	20
12.5.	Operation	21
12.6.	Static Electricity	21
12.7.	Limited Warranty	21
13.	Packaging	22
14.	Outline Drawing	23

1. General Description

The specification is a transmissive type color active matrix liquid crystal display (LCD) which uses amorphous thin film transistor (TFT) as switching devices. This product is composed of a TFT-LCD panel, driver Ics and a backlight unit.

2. Module Parameter

Features	Details	Unit
Display Size(Diagonal)	11.0"	
LCD type	TN TFT	
Display Mode	Transmissive / Normally White	
Resolution	1280 RGB x 120	Pixels
View Direction	6 O'clock	Best Image
Gray Scale Inversion Direction	12 O'clock	
Module Outline	288.92(H) x 41.2(V) x (7.2)(T) (Note1)	mm
Active Area	280.32 (H) x 27.0(V)	mm
Pixel Pitch	219(H) x 225(V)	um
Pixel Arrangement	RGB Vertical Stripe	
Display Colors	262K	
Interface	18-bit RGB Interface	
With or Without Touch Panel	Without	-
Controller IC	HX8290-A02 and HX8678-C01	
Operating Temperature	-10~60	°C
Storage Temperature	-20~70	°C
Weight	100	g

Note 1: Exclusive hooks, posts, PCB, FFC/FPC tail etc.

3. Absolute Maximum Ratings

$V_{SS}=0V$, $T_a=25^{\circ}C$

Item	Symbol	Min.	Max.	Unit
Logic Supply Voltage	VDD	-0.3	3.6	V
Storage temperature	T_{STG}	-20	+70	°C
Operating temperature	T_{OP}	-10	+60	°C

Note 1: If T_a below $50^{\circ}C$, the maximal humidity is 90%RH, if T_a over $50^{\circ}C$, absolute humidity should be less than 60%RH.

Note 2: The response time will be extremely slow when the operating temperature is around $-10^{\circ}C$, and the back ground will become darker at high temperature operating.

4. DC Characteristics

Item	Symbol	Min.	Typ.	Max.	Unit
Supply Voltage	VDD	-	3.3	-	V
Logic Low input voltage	V_{IL}	0	-	$0.2 \cdot VDD$	V
Logic High input voltage	V_{IH}	$0.8 \cdot VDD$	-	VDD	V
Logic Low output voltage	V_{OL}	0	-	$0.2 \cdot VDD$	V
Logic High output voltage	V_{OH}	$0.8 \cdot VDD$	-	VDD	V
Input Current	I_{dd}	-	TBD	-	mA

5. Backlight Characteristic

5.1. Backlight Characteristics

Item	Symbol	Condition	Min.	Typ.	Max.	Unit
Forward Voltage	V_{LED}	$T_a=25\text{ }^\circ\text{C}$, $I_F=20\text{mA/LED}$	9.0	9.6	10.5	V
Forward Current	I_{LED}	$T_a=25\text{ }^\circ\text{C}$, $V_F=3.2\text{V/LED}$	-	180	-	mA
Power dissipation	P_D		-	1728	-	mW
Uniformity	Avg		70	-	-	%
LED working life($25\text{ }^\circ\text{C}$)	-		-	30,000	-	Hrs
Drive method	Constant current					
LED Configuration	27 White LEDs (3 LEDs in one string and 9 groups in parallel)					

Note1: LED life time defined as follows: The final brightness is at 50% of original brightness.
The environmental conducted under ambient air flow, at $T_a=25 \pm 2\text{ }^\circ\text{C}$, $60\%RH \pm 5\%$, $I_F=20\text{mA}$

5.2. Backlighting circuit

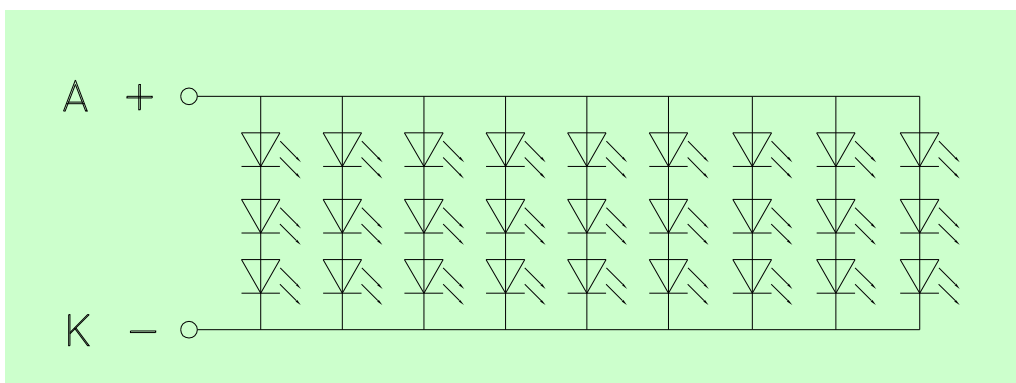

6. Optical Characteristics

6.1. Optical Characteristics

Ta=25°C, VDD=3.3V

	Item	Symbol	Condition	Specification			Unit	
				Min.	Typ.	Max.		
Backlight On (Transmissive Mode)	Luminance on TFT(I _F =20mA)	L _V	Normally viewing angle $\theta_x = \phi_y = 0^\circ$	720	900	-	cd/m ²	
	Contrast ratio(See 6.3)	CR		500	600	-		
	Response time (See 6.2)	T _R +T _F		-	35	-	ms	
	Chromaticity Transmissive (See 6.5)	Red	X _R	Center CR≥10	0.579	0.629	0.679	
			Y _R		0.302	0.352	0.402	
		Green	X _G		0.271	0.321	0.371	
			Y _G		0.596	0.646	0.696	
		Blue	X _B		0.092	0.142	0.192	
			Y _B		0.040	0.090	0.140	
	White	X _W	0.253	0.303	0.353			
Y _W		0.302	0.352	0.402				
Viewing Angle (See 6.4)	Horizontal	θ_{x+}	Center CR≥10	(55)	(70)	-	Deg.	
		θ_{x-}		(55)	(70)	-		
	Vertical	ϕ_{y+}		(55)	(70)	-		
		ϕ_{y-}		(35)	(50)	-		

6.2. Definition of Response Time

6.2.1. Normally Black Type (Negative)

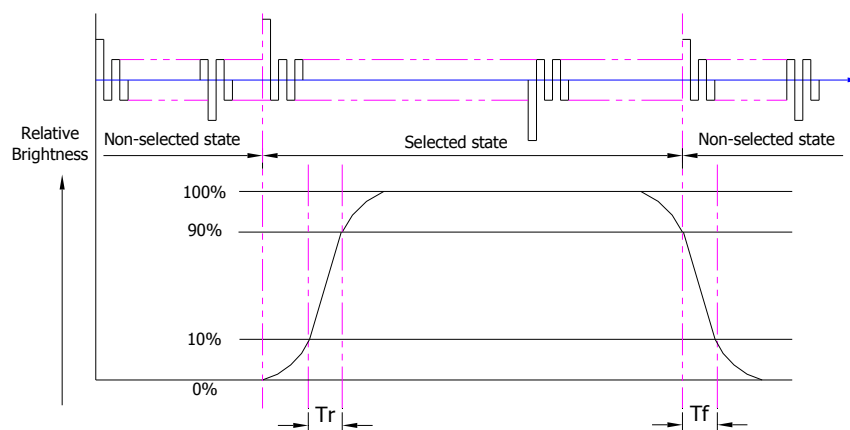

Tr is the time it takes to change from non-selected stage with relative luminance 10% to selected state with relative luminance 90%;

Tf is the time it takes to change from selected state with relative luminance 90% to non-selected state with relative luminance 10%.

Note : Measuring machine: LCD-5100

6.2.2. Normally White Type (Positive)

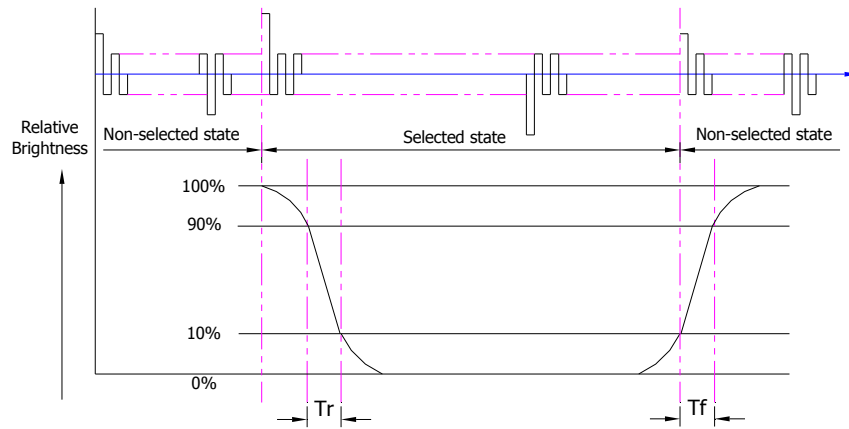

Tr is the time it takes to change from non-selected state with relative luminance 90% to selected state with relative luminance 10%;

Tf is the time it takes to change from selected state with relative luminance 10% to non-selected state with relative luminance 90%;

Note : Measuring machine: LCD-5100 or EQUI

6.3. Definition of Contrast Ratio

Contrast is measured perpendicular to display surface in reflective and transmissive mode.

The measurement condition is:

Measuring Equipment	Eldim or Equivalent
Measuring Point Diameter	3mm//1mm
Measuring Point Location	Active Area centre point
Test pattern	A: All Pixels white
	B: All Pixel black
Contrast setting	Maximum

Definitions: CR (Contrast) = Luminance of White Pixel / Luminance of Black Pixel

6.4. Definition of Viewing Angles

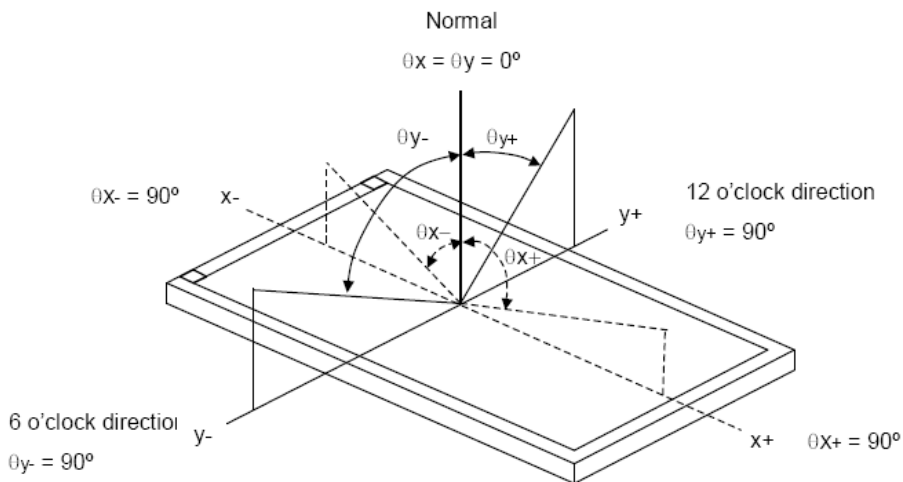

Measuring machine: LCD-5100 or EQUI

6.5. Definition of Color Appearance

R,G,B and W are defined by (x, y) on the IE chromaticity diagram

NTSC=area of RGB triangle/area of NTSC triangleX100%

Measuring picture: Red, Green, Blue and White (Measuring machine: BM-7)

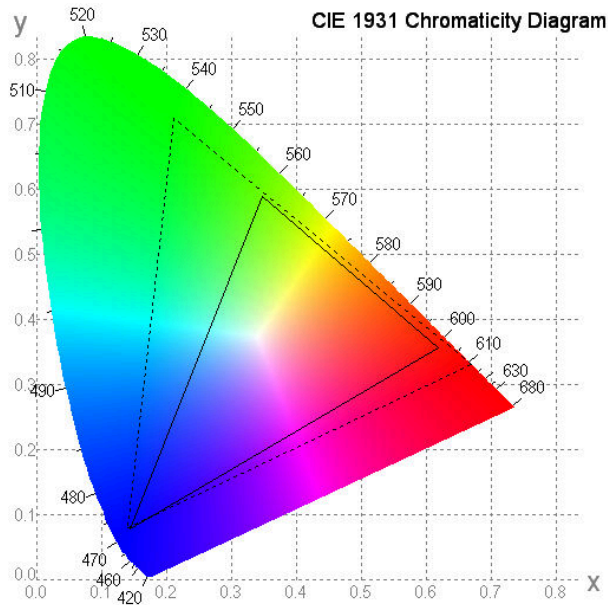

6.6. Definition of Surface Luminance, Uniformity and Transmittance

Using the transmissive mode measurement approach, measure the white screen luminance of the display panel and backlight.

6.6.1. Surface Luminance: $L_V = \text{average} (L_{P1}:L_{P9})$

6.6.2. Uniformity = Minimal ($L_{P1}:L_{P9}$) / Maximal ($L_{P1}:L_{P9}$) * 100%

6.6.3. Transmittance = L_V on LCD / L_V on Backlight * 100%

Note: Measuring machine: BM-7

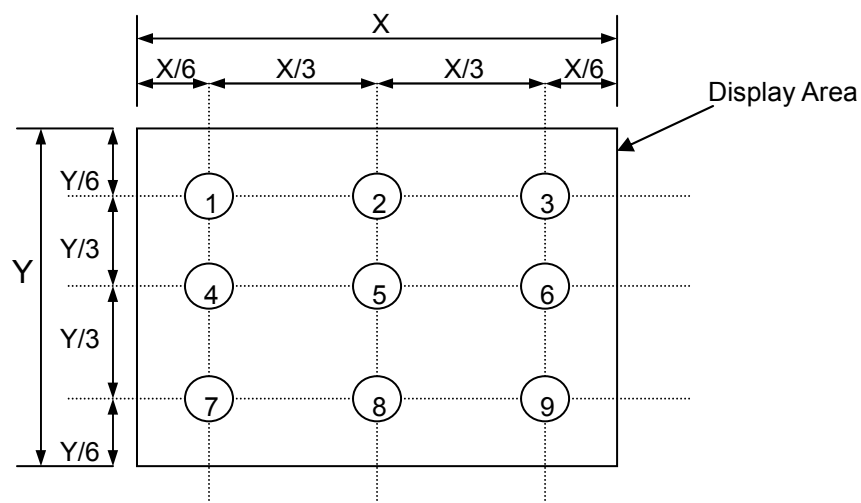

7. Block Diagram and Power Supply

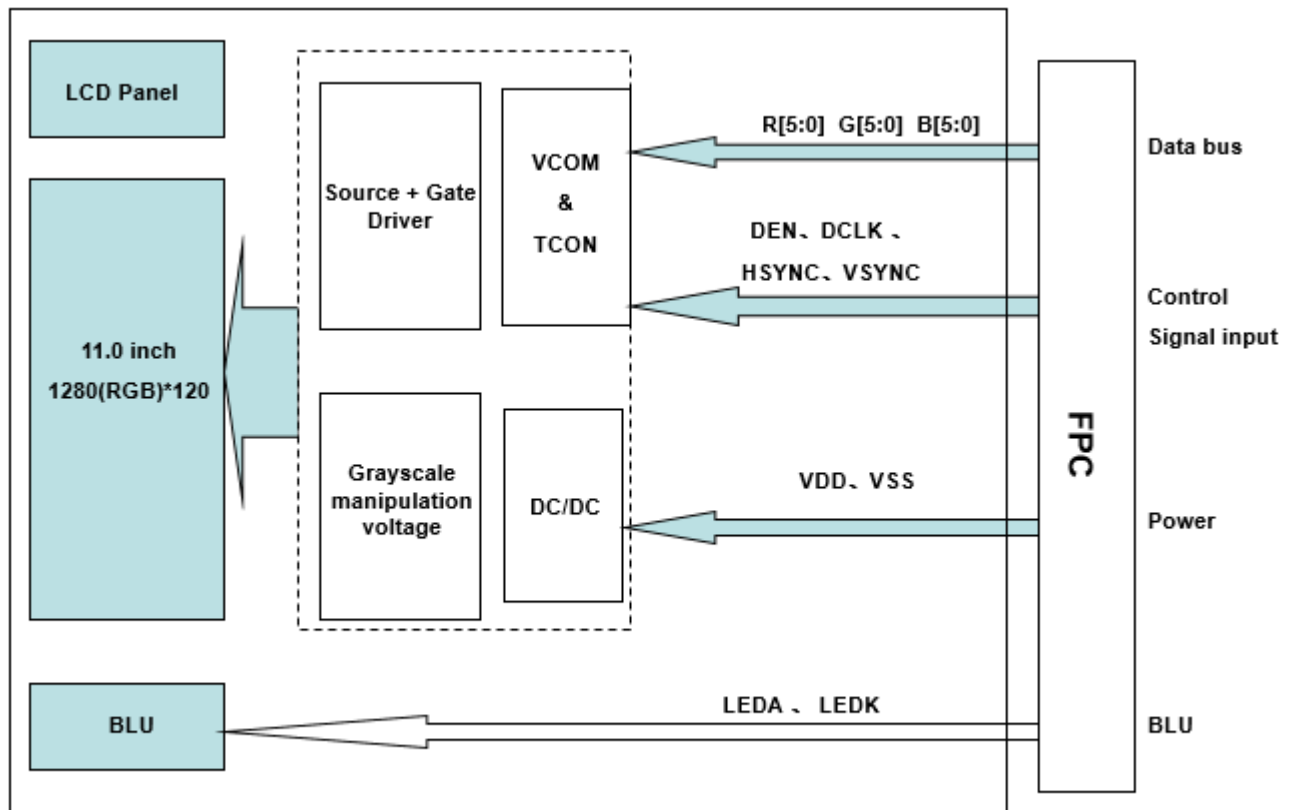

8. Interface Pins Definition

No.	Symbol	Function	Remark
1	VDD	Digital Power Supply.	
2	VDD	Digital Power Supply.	
3	B0	Blue Data.	
4	B1	Blue Data.	
5	B2	Blue Data.	
6	B3	Blue Data.	
7	B4	Blue Data.	
8	B5	Blue Data.	
9	VSS	Ground.	
10	G0	Green Data.	
11	G1	Green Data.	
12	G2	Green Data.	
13	G3	Green Data.	
14	G4	Green Data.	
15	G5	Green Data.	
16	VSS	Ground.	
17	R0	Red Data.	
18	R1	Red Data.	
19	R2	Red Data.	
20	R3	Red Data.	
21	R4	Red Data.	
22	R5	Red Data.	
23	VSS	Ground.	
24	DCLK	Data Clock.	
25	VSS	Ground.	
26	HSYNC	Horizontal Sync Signal.	
27	VSYNC	Vertical Sync Signal.	
28	DEN	Data Enable Signal.	
29	LEDK	Backlight LED Cathode.	
30	LEDA	Backlight LED Anode.	

9. Timing Chart

9.1. Input Clock and Data Timing Diagram

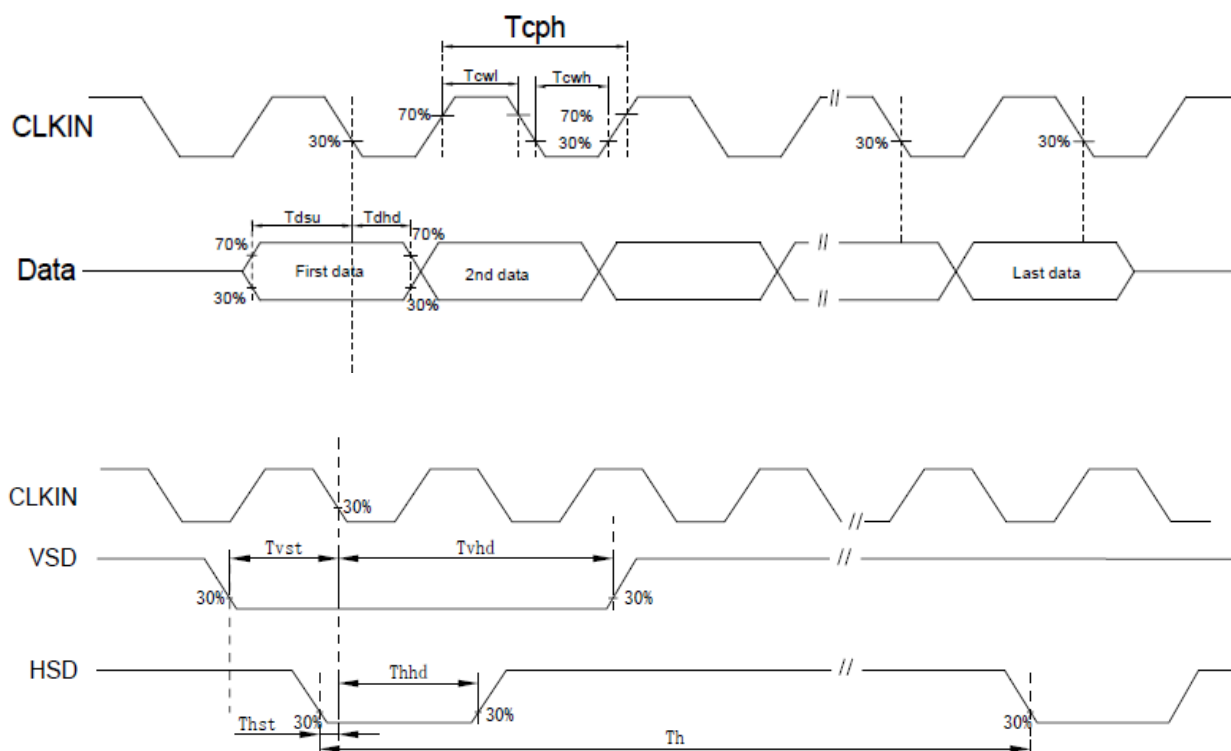

9.2. Data Input Format

Vertical input Format

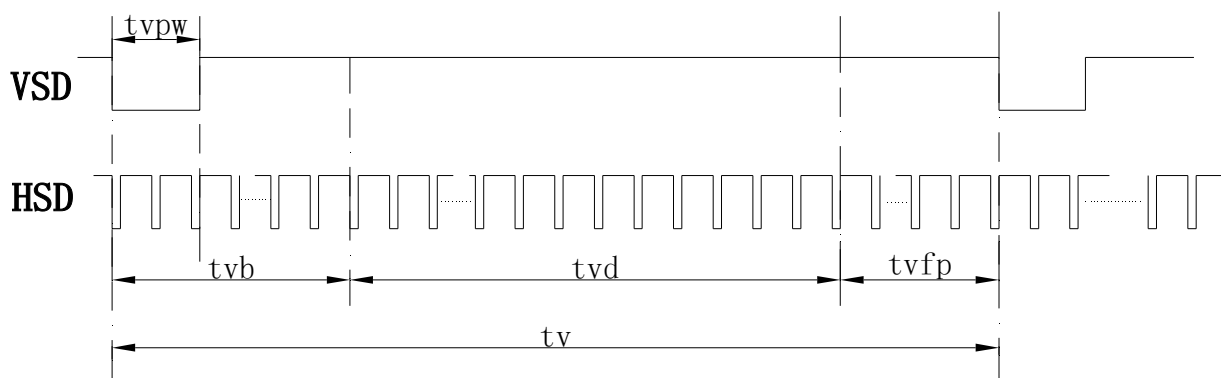

Horizontal input timing

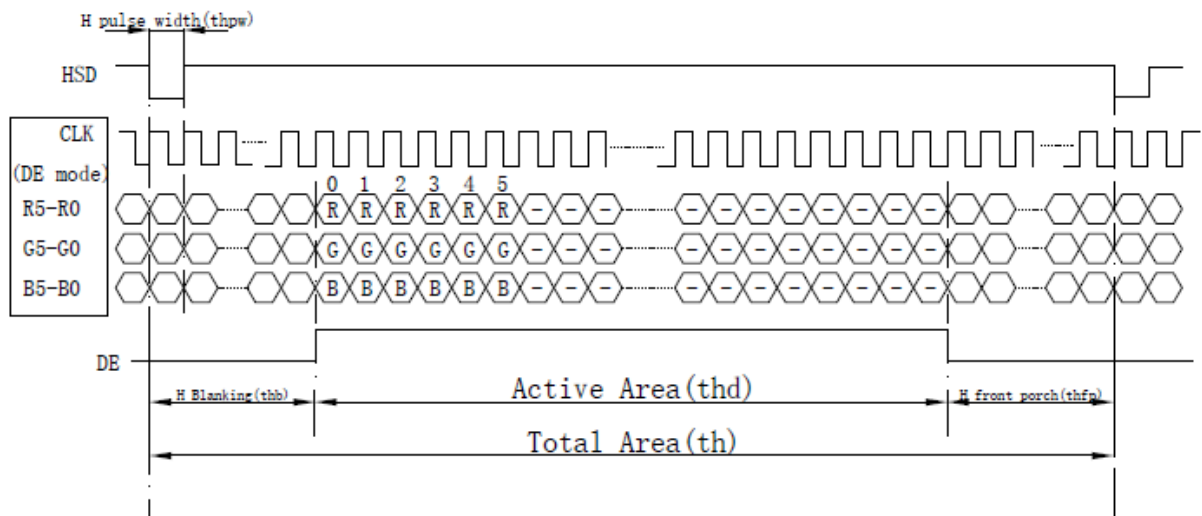

Timing Characteristics

Horizontal input timing

Parameter	Symbol	Value			Unit
		Min.	Typ.	Max.	
Horizontal display area	thd	1280			DCLK
DCLK frequency	fclk	-	(13)	-	MHZ
1 Horizontal Line	th	(1322)			DCLK
HSD pulse width	thpw	Min.	-		
		Typ.	(10)		
		Max.	-		
HSD Back Porch(Blanking)	thb	-	(16)	-	
HSD Front Porch	thfp	-	(26)	-	

Vertical input timing

Parameter	Symbol	Value			Unit
		Min.	Typ.	Max.	
Vertical display area	tvd	120			H
VSD period time	tv	-	(133)	-	H
VSD pulse width	tvpw	-	(2)	-	H
VSD Back Porch(Blanking)	tvb	-	(5)	-	H
VSD Front Porch	tvfp	-	(8)	-	H

10. Quality Assurance

10.1. Purpose

This standard for Quality Assurance assures the quality of LCD module products supplied to customer.

10.2.10.2 Standard for Quality Test

10.2.1 Sampling Plan:

GB2828.1-2012

Single sampling, general inspection level II

10.2.2 Sampling Criteria:

Visual inspection: AQL 1.5%

Electrical functional: AQL 0.65%.

10.2.3 Reliability Test:

Detailed requirement refer to Reliability Test Specification.

10.3. Nonconforming Analysis & Disposition

10.3.1 Nonconforming analysis:

10.3.1.1 Customer should provide overall information of non-conforming sample for their complaints.

10.3.1.2 After receipt of detailed information from customer, the analysis of nonconforming parts usually should be finished in one week.

10.3.1.3 If cannot finish the analysis on time, customer will be notified with the progress status.

10.3.2 Disposition of nonconforming:

10.3.2.1 Non-conforming product over PPM level will be replaced.

10.3.2.2 The cause of non-conformance will be analyzed. Corrective action will be discussed and implemented.

10.4. Agreement Items

Shall negotiate with customer if the following situation occurs:

10.4.1 There is any discrepancy in standard of quality assurance.

10.4.2 Additional requirement to be added in product specification.

10.4.3 Any other special problem.

10.5. Standard of the Product Visual Inspection

10.5.1 Appearance inspection:

10.5.1.1 The inspection must be under illumination about 1000 – 1500 lx, and the distance of view must be at 30cm ± 2cm.

10.5.1.2 The viewing angle should be 45° from the vertical line without reflection light or follows customer's viewing angle specifications.

10.5.1.3 Definition of area: A Zone: Active Area, B Zone: Viewing Area,

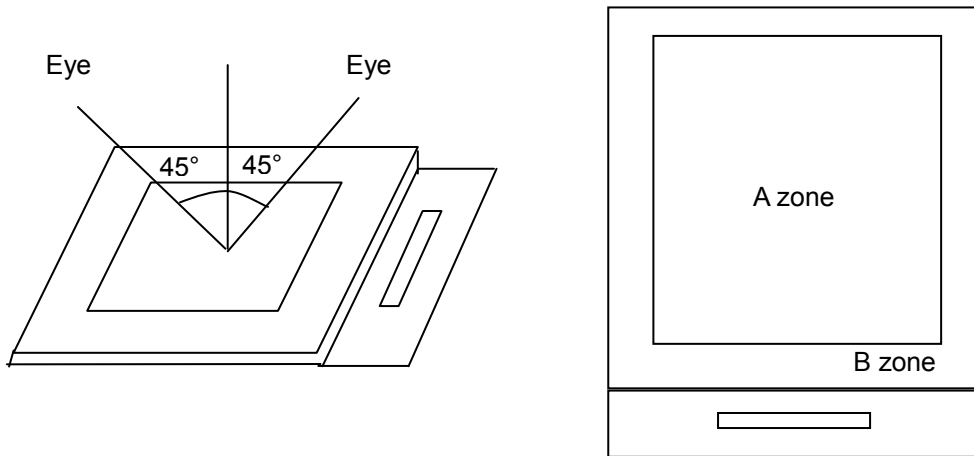

10.5.2 Basic principle:

10.5.2.1 A set of sample to indicate the limit of acceptable quality level must be discussed by both us and customer when there is any dispute happened.

10.5.2.2 New item must be added on time when it is necessary.

10.6. Inspection Specification

No.	Item	Criteria (Unit: mm)																		
01	Black / White spot Foreign material (Round type) Pinholes Stain Particles inside cell. (Minor defect)	<table border="1"> <thead> <tr> <th>Size</th> <th>Area</th> <th>Acc. Qty</th> </tr> </thead> <tbody> <tr> <td>$\varphi \leq 0.20$</td> <td></td> <td>Ignore</td> </tr> <tr> <td>$0.20 < \varphi \leq 0.50$</td> <td></td> <td>$N \leq 6$</td> </tr> <tr> <td>$0.50 < \varphi \leq 0.70$</td> <td></td> <td>$N \leq 2$</td> </tr> <tr> <td>$0.70 < \varphi$</td> <td></td> <td>0</td> </tr> </tbody> </table> <p> $\varphi = (a + b) / 2$ Distance between 2 defects should more than 5mm apart. </p>	Size	Area	Acc. Qty	$\varphi \leq 0.20$		Ignore	$0.20 < \varphi \leq 0.50$		$N \leq 6$	$0.50 < \varphi \leq 0.70$		$N \leq 2$	$0.70 < \varphi$		0			
Size	Area	Acc. Qty																		
$\varphi \leq 0.20$		Ignore																		
$0.20 < \varphi \leq 0.50$		$N \leq 6$																		
$0.50 < \varphi \leq 0.70$		$N \leq 2$																		
$0.70 < \varphi$		0																		
02	Electrical Defect (Minor defect)	<table border="1"> <thead> <tr> <th>Bright dot</th> <th>Display Area</th> <th>Total</th> <th rowspan="3">Note1</th> </tr> </thead> <tbody> <tr> <td></td> <td>$N \leq 2$</td> <td>$N \leq 2$</td> </tr> <tr> <td>Dark dot</td> <td>$N \leq 4$</td> <td>$N \leq 4$</td> </tr> <tr> <td>Total dot</td> <td>$N \leq 4$</td> <td>$N \leq 4$</td> <td></td> </tr> <tr> <td>Mura</td> <td colspan="2">Not visible through 5% ND filters.</td> <td>Note 2</td> </tr> </tbody> </table> <p>Remark: 1. Bright dot caused by scratch and foreign object accords to item 1.</p>	Bright dot	Display Area	Total	Note1		$N \leq 2$	$N \leq 2$	Dark dot	$N \leq 4$	$N \leq 4$	Total dot	$N \leq 4$	$N \leq 4$		Mura	Not visible through 5% ND filters.		Note 2
Bright dot	Display Area	Total	Note1																	
	$N \leq 2$	$N \leq 2$																		
Dark dot	$N \leq 4$	$N \leq 4$																		
Total dot	$N \leq 4$	$N \leq 4$																		
Mura	Not visible through 5% ND filters.		Note 2																	

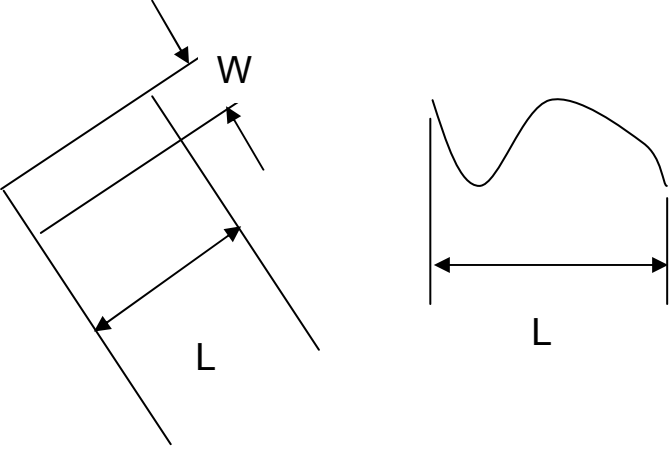
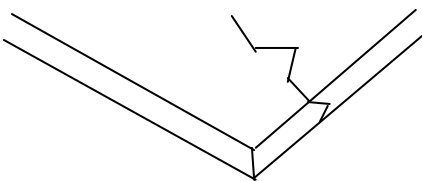
03	Black and White line Scratch Foreign material (Line type) (Minor defect)	 <table border="1" data-bbox="598 705 1220 974"> <thead> <tr> <th>Length</th> <th>Width</th> <th>Acc. Qty</th> </tr> </thead> <tbody> <tr> <td>/</td> <td>$W \leq 0.1$</td> <td>Ignore</td> </tr> <tr> <td>$L \leq 2.5$</td> <td>$0.1 < W \leq 0.2$</td> <td>3</td> </tr> <tr> <td>$L > 2.5$</td> <td>$0.2 < W$</td> <td>0</td> </tr> <tr> <td colspan="2">Total</td> <td>3</td> </tr> </tbody> </table> <p data-bbox="539 1019 1420 1086">Distance between 2 defects should more than 3mm apart. Scratches not viewable through the back of the display are acceptable.</p>	Length	Width	Acc. Qty	/	$W \leq 0.1$	Ignore	$L \leq 2.5$	$0.1 < W \leq 0.2$	3	$L > 2.5$	$0.2 < W$	0	Total		3
Length	Width	Acc. Qty															
/	$W \leq 0.1$	Ignore															
$L \leq 2.5$	$0.1 < W \leq 0.2$	3															
$L > 2.5$	$0.2 < W$	0															
Total		3															
04	Glass Crack (Minor defect)	 <p data-bbox="539 1388 1165 1422">Crack is potential to enlarge, any type is not allowed.</p>															

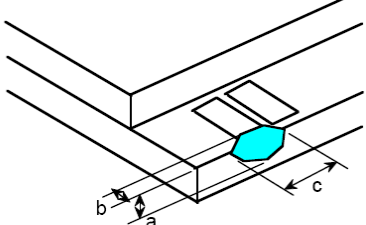
05	Glass Chipping Pad Area: (Minor defect)	 <table border="1" data-bbox="861 1702 1332 1870"> <thead> <tr> <th>Length and Width</th> <th>Acc. Qty</th> </tr> </thead> <tbody> <tr> <td>$c > 3.0, b < 1.0$</td> <td>1</td> </tr> <tr> <td>$c < 3.0, b < 1.0$</td> <td>3</td> </tr> <tr> <td colspan="2">$a < \text{Glass Thickness}$</td> </tr> </tbody> </table>	Length and Width	Acc. Qty	$c > 3.0, b < 1.0$	1	$c < 3.0, b < 1.0$	3	$a < \text{Glass Thickness}$	
Length and Width	Acc. Qty									
$c > 3.0, b < 1.0$	1									
$c < 3.0, b < 1.0$	3									
$a < \text{Glass Thickness}$										

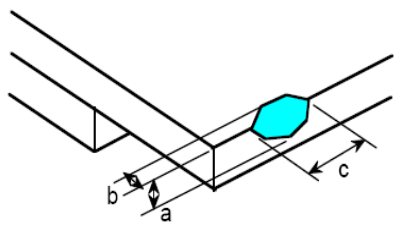
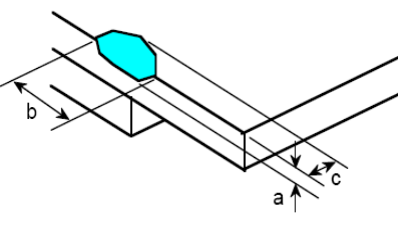
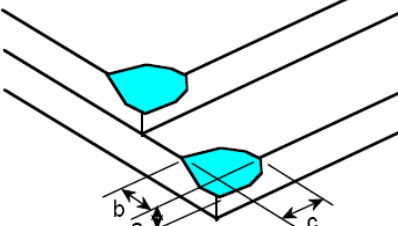
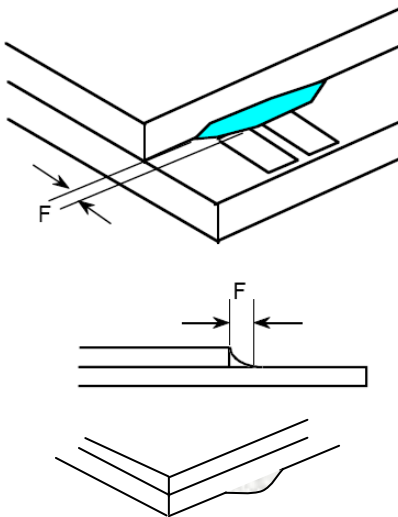
<p>06</p>	<p>Glass Chipping Rear of Pad Area: (Minor defect)</p> 	<table border="1"> <thead> <tr> <th>Length and Width</th> <th>Acc. Qty</th> </tr> </thead> <tbody> <tr> <td>$c > 3.0, b < 1.0$</td> <td>1</td> </tr> <tr> <td>$c < 3.0, b < 1.0$</td> <td>2</td> </tr> <tr> <td>$c < 3.0, b < 0.5$</td> <td>4</td> </tr> <tr> <td colspan="2" style="text-align: center;">$a < \text{Glass Thickness}$</td> </tr> </tbody> </table>	Length and Width	Acc. Qty	$c > 3.0, b < 1.0$	1	$c < 3.0, b < 1.0$	2	$c < 3.0, b < 0.5$	4	$a < \text{Glass Thickness}$	
Length and Width	Acc. Qty											
$c > 3.0, b < 1.0$	1											
$c < 3.0, b < 1.0$	2											
$c < 3.0, b < 0.5$	4											
$a < \text{Glass Thickness}$												
<p>07</p>	<p>Glass Chipping Except Pad Area: (Minor defect)</p> 	<table border="1"> <thead> <tr> <th>Length and Width</th> <th>Acc. Qty</th> </tr> </thead> <tbody> <tr> <td>$c > 3.0, b < 1.0$</td> <td>1</td> </tr> <tr> <td>$c < 3.0, b < 1.0$</td> <td>2</td> </tr> <tr> <td>$c < 3.0, b < 0.5$</td> <td>4</td> </tr> <tr> <td colspan="2" style="text-align: center;">$a < \text{Glass Thickness}$</td> </tr> </tbody> </table>	Length and Width	Acc. Qty	$c > 3.0, b < 1.0$	1	$c < 3.0, b < 1.0$	2	$c < 3.0, b < 0.5$	4	$a < \text{Glass Thickness}$	
Length and Width	Acc. Qty											
$c > 3.0, b < 1.0$	1											
$c < 3.0, b < 1.0$	2											
$c < 3.0, b < 0.5$	4											
$a < \text{Glass Thickness}$												
<p>08</p>	<p>Glass Corner Chipping: (Minor defect)</p> 	<table border="1"> <thead> <tr> <th>Length and Width</th> <th>Acc. Qty</th> </tr> </thead> <tbody> <tr> <td>$c < 3.0, b < 3.0$</td> <td>Ignore</td> </tr> <tr> <td colspan="2" style="text-align: center;">$a < \text{Glass Thickness}$</td> </tr> </tbody> </table>	Length and Width	Acc. Qty	$c < 3.0, b < 3.0$	Ignore	$a < \text{Glass Thickness}$					
Length and Width	Acc. Qty											
$c < 3.0, b < 3.0$	Ignore											
$a < \text{Glass Thickness}$												
<p>09</p>	<p>Glass Burr: (Minor defect)</p> 	<table border="1"> <thead> <tr> <th>Length</th> <th>Acc. Qty</th> </tr> </thead> <tbody> <tr> <td>$F < 1.0$</td> <td>Ignore</td> </tr> </tbody> </table> <p>Glass burr don't affect assemble and module dimension.</p>	Length	Acc. Qty	$F < 1.0$	Ignore						
Length	Acc. Qty											
$F < 1.0$	Ignore											

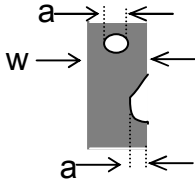
10	<p>FPC Defect: (Minor defect)</p> 	<p>10.1 Dent, pinhole width $a < w/3$. (w: circuitry width.) 10.2 Open circuit is unacceptable. 10.3 No oxidation, contamination and distortion.</p>								
11	Bubble on Polarizer (Minor defect)	<table border="1" data-bbox="737 593 1206 766"> <thead> <tr> <th>Diameter</th> <th>Acc. Qty</th> </tr> </thead> <tbody> <tr> <td>$\varphi \leq 0.30$</td> <td>Ignore</td> </tr> <tr> <td>$0.30 < \varphi \leq 0.50$</td> <td>$N \leq 2$</td> </tr> <tr> <td>$0.50 < \varphi$</td> <td>$N=0$</td> </tr> </tbody> </table>	Diameter	Acc. Qty	$\varphi \leq 0.30$	Ignore	$0.30 < \varphi \leq 0.50$	$N \leq 2$	$0.50 < \varphi$	$N=0$
Diameter	Acc. Qty									
$\varphi \leq 0.30$	Ignore									
$0.30 < \varphi \leq 0.50$	$N \leq 2$									
$0.50 < \varphi$	$N=0$									
12	Dent on Polarizer (Minor defect)	<table border="1" data-bbox="737 835 1206 1008"> <thead> <tr> <th>Diameter</th> <th>Acc. Qty</th> </tr> </thead> <tbody> <tr> <td>$\varphi \leq 0.25$</td> <td>Ignore</td> </tr> <tr> <td>$0.25 < \varphi \leq 0.50$</td> <td>$N \leq 4$</td> </tr> <tr> <td>$0.50 < \varphi$</td> <td>None</td> </tr> </tbody> </table>	Diameter	Acc. Qty	$\varphi \leq 0.25$	Ignore	$0.25 < \varphi \leq 0.50$	$N \leq 4$	$0.50 < \varphi$	None
Diameter	Acc. Qty									
$\varphi \leq 0.25$	Ignore									
$0.25 < \varphi \leq 0.50$	$N \leq 4$									
$0.50 < \varphi$	None									
13	Bezel	<p>13.1 No rust, distortion on the Bezel. 13.2 No visible fingerprints, stains or other contamination.</p>								
14	Touch Panel	<p>D: Diameter W: width L: length 14.1 Spot: $D < 0.25$ is acceptable $0.25 \leq D \leq 0.4$ 2dots are acceptable and the distance between defects should more than 10 mm. $D > 0.4$ is unacceptable 14.2 Dent: $D > 0.40$ is unacceptable 14.3 Scratch: $W \leq 0.03$, $L \leq 10$ is acceptable, $0.03 < W \leq 0.10$, $L \leq 10$ is acceptable Distance between 2 defects should more than 10 mm. $W > 0.10$ is unacceptable.</p>								
15	PCB	<p>15.1 No distortion or contamination on PCB terminals. 15.2 All components on PCB must same as documented on the BOM/component layout. 15.3 Follow IPC-A-600F.</p>								
16	Soldering	Follow IPC-A-610C standard								

17	Electrical Defect (Major defect)	<p>The below defects must be rejected.</p> <p>17.1 Missing vertical / horizontal segment, 17.2 Abnormal Display. 17.3 No function or no display. 17.4 Current exceeds product specifications. 17.5 LCD viewing angle defect. 17.6 No Backlight. 17.7 Dark Backlight. 17.8 Touch Panel no function.</p>
----	-------------------------------------	------------------------------------------------------------------------------------------------------------------------------------------------------------------------------------------------------------------------------------------------------------------------------------------------------------------------------------

Remark: LCD Panel Broken shall be rejected. Defect out of LCD viewing area is acceptable.

10.7. Classification of Defects

10.7.1 Visual defects (Except no / wrong label) are treated as minor defect and electrical defect is major.

10.7.2 Two minor defects are equal to one major in lot sampling inspection.

10.8. Identification/marketing criteria

Any unit with illegible / wrong /double or no marking/ label shall be rejected.

10.9. Packaging

10.9.1 There should be no damage of the outside carton box, each packaging box should have one identical label.

10.9.2 Modules inside package box should have compliant mark.

10.9.3 All direct package materials shall offer ESD protection.

Note1: Bright dot is defined as the defective area of the dot is larger than 50% of one sub-pixel area.

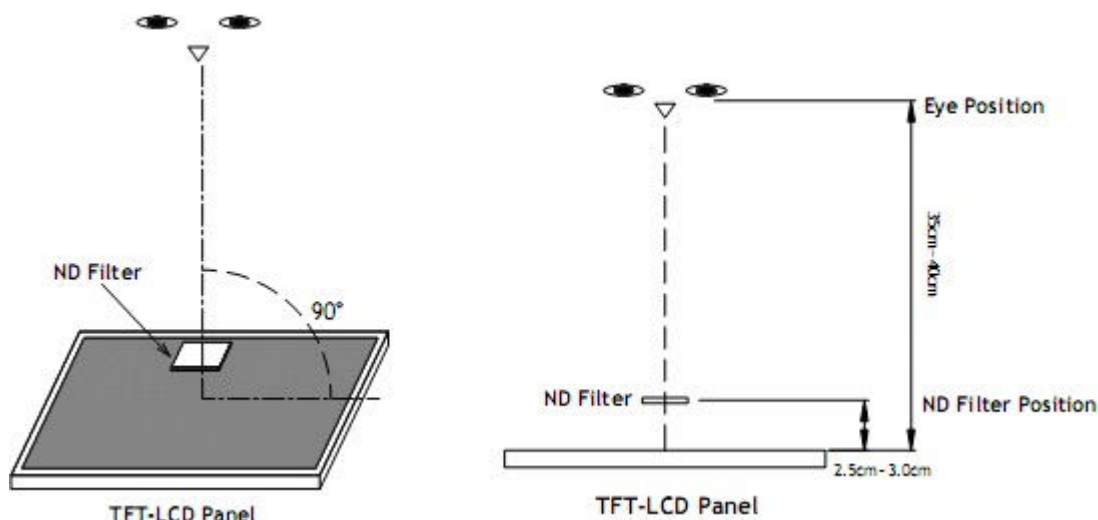

Bright dot: The bright dot size defect at black display pattern. It can be recognized by 2% transparency of filter when the distance between eyes and panel is $350\text{mm} \pm 50\text{mm}$.

Dark dot: Cyan, Magenta or Yellow dot size defect at white display pattern. It can be recognized by 5% transparency of filter when the distance between eyes and panel is $350\text{mm} \pm 50\text{mm}$.

Note2: Mura on display which appears darker / brighter against background brightness on parts of display area.

11. Reliability Specification

No	Item	Condition	Quantity	Criteria
1	High Temperature Operating	60°C, 96Hrs	2	GB/T2423.2-2008
2	Low Temperature Operating	-10°C, 96Hrs	2	GB/T2423.1-2008
3	High Humidity	50°C, 90%RH, 96Hrs	2	GB/T2423.3-2006
4	High Temperature Storage	70°C, 96Hrs	2	GB/T2423.2-2008
5	Low Temperature Storage	-20°C, 96Hrs	2	GB/T2423.1-2008
6	Thermal Cycling Test	-10°C, 60min~60°C, 60min, 20 cycles.	2	GB/T2423.22-2012
7	Packing vibration	Frequency range:10Hz~50Hz Acceleration of gravity:5G X, Y, Z 30 min for each direction.	2	GB/T5170.14-2009
8	Electrical Static Discharge	Air: ±8KV 150pF/330Ω 5 times Contact: ±4KV 150pF/330Ω 5 times	2	GB/T17626.2-2006
9	Drop Test (Packaged)	Height:80 cm,1 corner, 3 edges, 6 surfaces.	2	GB/T2423.8-1995

Note1. No deflection cosmetic and operational function allowable.

Note2. Total current Consumption should be below double of initial value

12. Precautions and Warranty

12.1. Safety

12.1.1 The liquid crystal in the LCD is poisonous. Do not put it in your mouth. If the liquid crystal touches your skin or clothes, wash it off immediately using soap and water.

12.1.2 Since the liquid crystal cells are made of glass, do not apply strong impact on them. Handle with care.

12.2. Handling

12.2.1 Reverse and use within ratings in order to keep performance and prevent damage.

12.2.2 Do not wipe the polarizer with dry cloth, as it might cause scratch. If the surface of the LCD needs to be cleaned, wipe it swiftly with cotton or other soft cloth soaked with petroleum IPA, do not use other chemicals.

12.3. Storage

12.3.1 Do not store the LCD module beyond the specified temperature ranges.

12.3.2 Strong light exposure causes degradation of polarizer and color filter.

12.4. Metal Pin (Apply to Products with Metal Pins)

12.4.1 Pins of LCD and Backlight

12.4.1.1 Solder tip can touch and press on the tip of Pin LEAD during the soldering

12.4.1.2 Recommended Soldering Conditions

Solder Type: Sn96.3~94-Ag3.3~4.3-Cu0.4~1.1

Maximum Solder Temperature: 370℃

Maximum Solder Time: 3s at the maximum temperature

Recommended Soldering Temp: 350±20℃

Typical Soldering Time: ≤3s

12.4.1.3 Solder Wetting

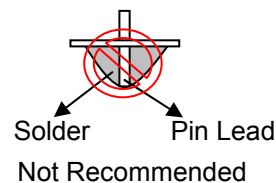
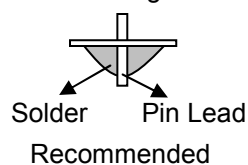

12.4.2 Pins of EL

12.4.2.1 Solder tip can touch and press on the tip of EL leads during soldering.

12.4.2.2 No Solder Paste on the soldering pad on the motherboard is recommended.

12.4.2.3 Recommended Soldering Conditions

Solder type: Nippon Alimit Leadfree SR-34, size 0.5mm

Recommended Solder Temperature: 270~290℃

Typical Soldering Time: ≤2s

Minimum solder distance from EL lamp (body): 2.0mm

12.4.2.4 No horizontal press on the EL leads during soldering.

12.4.2.5 180° bend EL leads three times is not allowed.

12.4.2.6 Solder Wetting

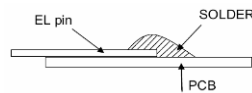

Recommended

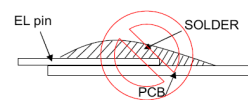

Not Recommended

12.4.2.7 The type of the solder iron:

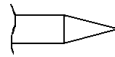

Recommended

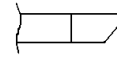

Not Recommended

12.4.2.8 Solder Pad

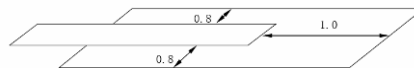

12.5. Operation

- 12.5.1. Do not drive LCD with DC voltage
- 12.5.2. Response time will increase below lower temperature
- 12.5.3. Display may change color with different temperature
- 12.5.4. Mechanical disturbance during operation, such as pressing on the display area, may cause the segments to appear "fractured".
- 12.5.5. Do not connect or disconnect the LCM to or from the system when power is on.
- 12.5.6. Never use the LCM under abnormal condition of high temperature and high humidity.
- 12.5.7. Module has high frequency circuits. Sufficient suppression to the electromagnetic interface shall be done by system manufacturers. Grounding and shielding methods may be important to minimize the interference.
- 12.5.8. Do not display the fixed pattern for long time (we suggest the time not longer than one hour) because it may develop image sticking due to the TFT structure.

12.6. Static Electricity

- 12.6.1. CMOS LSIs are equipped in this unit, so care must be taken to avoid the electro-static charge, by ground human body, etc.
- 12.6.2. The normal static prevention measures should be observed for work clothes and benches.
- 12.6.3. The module should be kept into anti-static bags or other containers resistant to static for storage.

12.7. Limited Warranty

- 12.7.1. Our warranty liability is limited to repair and/or replacement. We will not be responsible for any consequential loss.
- 12.7.2. If possible, we suggest customer to use up all modules in six months. If the module storage time over twelve months, we suggest that recheck it before the module be used.
- 12.7.3. After the product shipped, any product quality issues must be feedback within three months, otherwise, we will not be responsible for the subsequent or consequential events.

13. Packaging

TBD

14. Outline Drawing

