

PRODUCT SPECIFICATION

9.0" TFT LCD MODULE

MODEL:T090102600-A0TMN-002 Ver:1.1



< ◇ > Preliminary Specification

< ◆ > Finally Specification

CUSTOMER'S APPROVAL	
CUSTOMER :	
SIGNATURE:	DATE:

APPROVED BY	PM REVIEWED	PD REVIEWED	PREPARED BY

Revision History

Revision	Date	Originator	Detail	Remarks
1.0	2017.06.22	ZFY	Initial Release	
1.1	2018.04.23	ZFY	Modify many details	P22/P23

Table of Contents

No.	Item	Page
1.	General Description.....	4
2.	Module Parameter.....	4
3.	Absolute Maximum Ratings.....	4
4.	DC Characteristics	5
5.	Backlight Characteristic.....	5
5.1.	Backlight Characteristic.....	5
5.2.	Backlighting circuit.....	5
6.	Touch Screen Panel Specifications	5
7.	Optical Characteristics	6
7.1.	Definition of Response Time	6
7.2.	Definition of Contrast Ratio	7
7.3.	Definition of Viewing Angles	7
7.4.	Definition of Color Appearance.....	8
7.5.	Definition of Surface Luminance, Uniformity and Transmittance	8
8.	Block Diagram and Power Supply.....	9
9.	Interface Pins Definition	10
10.	AC characteristics	12
10.1.	LVDS mode AC electrical characteristic.....	12
10.2.	Data Input Format for LVDS	14
11.	Quality Assurance	15
11.1	Purpose	15
11.2	Standard for Quality Test	15
11.3	Nonconforming Analysis & Disposition.....	15
11.4	Agreement Items	15
11.5	Standard of the Product Visual Inspection	15
11.6	Inspection Specification for the TFT module	16
11.8	Classification of Defects.....	20
11.9	Identification/marketing criteria.....	20
11.10	Packaging.....	20
12.	Reliability Specification.....	21
13.	Precautions and Warranty.....	22
13.1	Safety	22
13.2	Handling	22
13.3	Storage	22
13.4	Metal Pin (Apply to Products with Metal Pins).....	22
13.5	Operation.....	23
13.6	Static Electricity	23
13.7	Limited Warranty	23
14.	Packaging.....	24
15.	Outline Drawing.....	25

1. General Description

The specification is a transmissive type color active matrix liquid crystal display (LCD) which uses amorphous thin film transistor (TFT) as switching devices. This product is composed of a TFT-LCD panel, driver ICs and a backlight unit.

2. Module Parameter

Features	Details	Unit
Display Size(Diagonal)	9.0"	
LCD type	TN TFT	
Display Mode	Transmissive/Normally white	
Resolution	1024 RGB x 600	Pixels
View Direction	10:30 o'clock	Best Image
Gray scale inversion direction	4:30 o'clock	
Module Outline	211.1(H) x 126.5(V) x 5.6(T) (Note1)	mm
Active Area	196.608 (H) x 114.15 (V)	mm
Pixel Pitch	192 (H) x 190.25 (V)	um
Pixel Arrangement	Stripe RGB	
Polarizer Surface Treatment	Anti-glare	
Display Colors	16.7 M	
Interface	LVDS Interface	
With or Without Touch Panel	Without	
Operating Temperature	-20~70	°C
Storage Temperature	-30~80	°C
Weight	TBD	g

Note 1: Exclusive hooks, posts, FFC/FPC tail etc.

3. Absolute Maximum Ratings

$V_{SS}=0V, T_a=25^{\circ}C$

Item	Symbol	Min.	Max.	Unit
Supply Voltage	DVDD	-0.5	3.96	V
	AVDD	-0.5	14.85	
Storage temperature	T_{STG}	-30	+80	°C
Operating temperature	T_{OP}	-20	+70	°C

Note 1: If T_a below $50^{\circ}C$, the maximal humidity is 90%RH, if T_a over $50^{\circ}C$, absolute humidity should be less than 60%RH.

Note 2: The response time will be extremely slow when the operating temperature is around $-10^{\circ}C$, and the back ground will become darker at high temperature operating.

4. DC Characteristics

Item	Symbol	Min.	Typ.	Max.	Unit	Remark	
Supply Voltage	DVDD	2.3	-	3.6	V		
	AVDD	(9)	(9.2)	(9.4)	V		
	VGH	17	18	19	V		
	VGL	-7	-6	-5	V		
	VCOM	3.21	3.41	3.61	V	NOTE 1	
Differential input threshold voltage	High	RxVTH	-	-	0.1	V	
	Low	RxVTL	-0.1	-	-	V	
Input voltage range(singled-end)	RxVIN	0	-	DVDD-1.2+ Vid /2	V		
Differential input voltage	Vid	0.2	-	0.6	V		

Note 1: Typ. VCOM is only a reference value, it must be optimized according to each LCM. Be sure to use VR

5. Backlight Characteristic

5.1. Backlight Characteristic

Item	Symbol	Condition	Min.	Typ.	Max.	Unit
Forward Voltage	V _F	T _a =25 °C, I _F =20mA/LED	8.4	9.6	10.2	V
Forward Current	I _F	T _a =25 °C, V _F =3.2V/LED	-	180	-	mA
Power dissipation	P _D			1728		mW
Uniformity	Avg		70	-	-	%
Drive method	Constant current					
LED Configuration	27 White LEDs (3 LEDs in string and 9 groups in parallel)					

5.2. Backlighting circuit

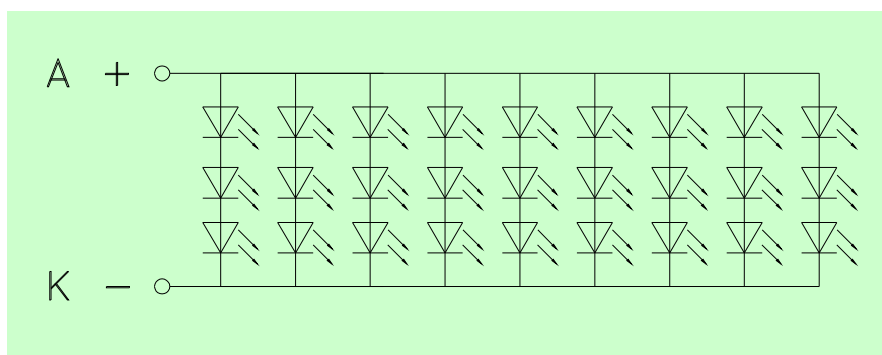

6. Touch Screen Panel Specifications

Without TP

7. Optical Characteristics

Ta=25°C, DVDD=3.3V

	Item	Symbol	Condition	Specification			Unit	
				Min.	Typ.	Max.		
Backlight On (Transmissive Mode)	Luminance on TFT($I_f=20\text{mA/LED}$)	Lv		280	350	-	cd/m ²	
	Contrast ratio(See 6.3)	CR		-	500	-		
	Response time (See 6.2)	TR+TF		-	25	-	ms	
	Chromaticity Transmissive (See 6.5)	Red	X _R	Center CR≥10		TBD		
			Y _R			TBD		
		Green	X _G			TBD		
			Y _G			TBD		
		Blue	X _B			TBD		
			Y _B			TBD		
	White	X _W		TBD				
Y _W			TBD					
Viewing Angle (See 6.4)	Horizontal	θ _{X+}	Center CR≥10		70	-	Deg.	
		θ _{X-}			70	-		
	Vertical	φ _{Y+}			70	-		
		φ _{Y-}			70	-		
NTSC Ratio					50	-	%	

7.1. Definition of Response Time

7.1.1. Normally Black Type (Negative)

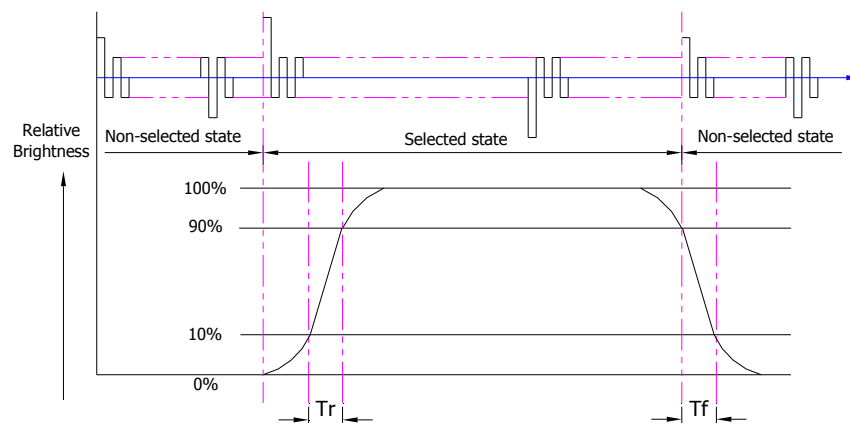

Tr is the time it takes to change from non-selected stage with relative luminance 10% to selected state with relative luminance 90%;

Tf is the time it takes to change from selected state with relative luminance 90% to non-selected state with relative luminance 10%.

Note: Measuring machine: LCD-5100

7.1.2. Normally White Type (Positive)

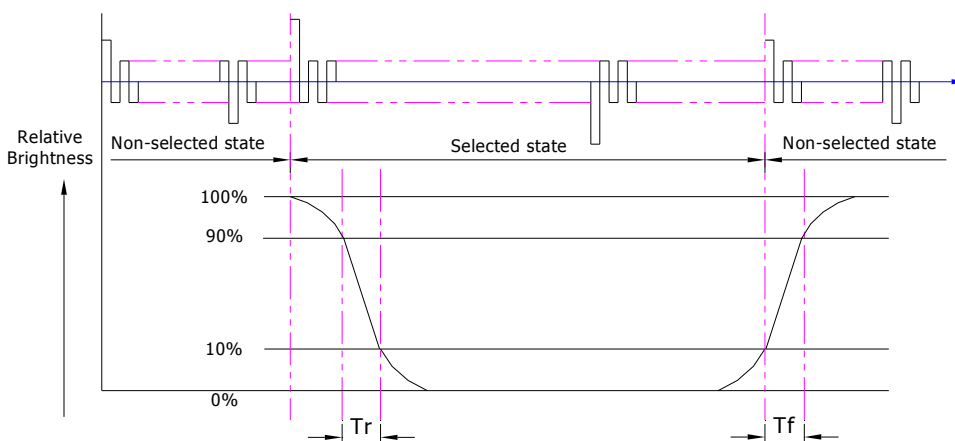

Tr is the time it takes to change from non-selected state with relative luminance 90% to selected state with relative luminance 10%;

Tf is the time it takes to change from selected state with relative luminance 10% to non-selected state with relative luminance 90%;

Note: Measuring machine: LCD-5100 or EQUI

7.2. Definition of Contrast Ratio

Contrast is measured perpendicular to display surface in reflective and transmissive mode. The measurement condition is:

Measuring Equipment	Eldim or Equivalent
Measuring Point Diameter	3mm//1mm
Measuring Point Location	Active Area centre point
Test pattern	A: All Pixels white
	B: All Pixel black
Contrast setting	Maximum

Definitions: CR (Contrast) = Luminance of White Pixel / Luminance of Black Pixel

7.3. Definition of Viewing Angles

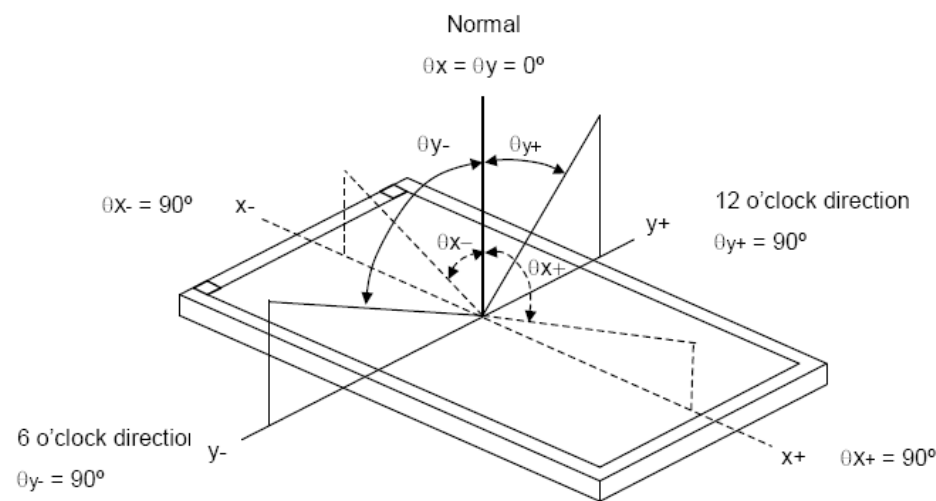

Measuring machine: LCD-5100 or EQUI

7.4. Definition of Color Appearance

R,G,B and W are defined by (x, y) on the IE chromaticity diagram

NTSC=area of RGB triangle/area of NTSC triangleX100%

Measuring picture: Red, Green, Blue and White (Measuring machine: BM-7)

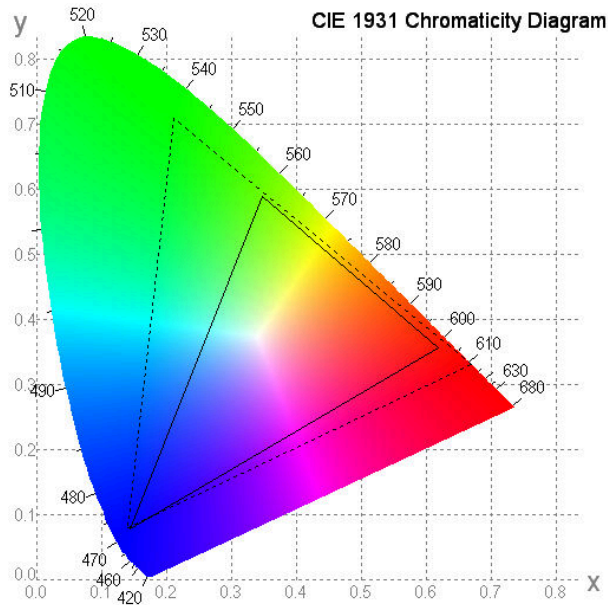

7.5. Definition of Surface Luminance, Uniformity and Transmittance

Using the transmissive mode measurement approach, measure the white screen luminance of the display panel and backlight.

7.5.1. Surface Luminance: $L_V = \text{average} (L_{P1}:L_{P9})$

7.5.2. Uniformity = Minimal ($L_{P1}:L_{P9}$) / Maximal ($L_{P1}:L_{P9}$) * 100%

7.5.3. Transmittance = L_V on LCD / L_V on Backlight * 100%

Note: Measuring machine: BM-7

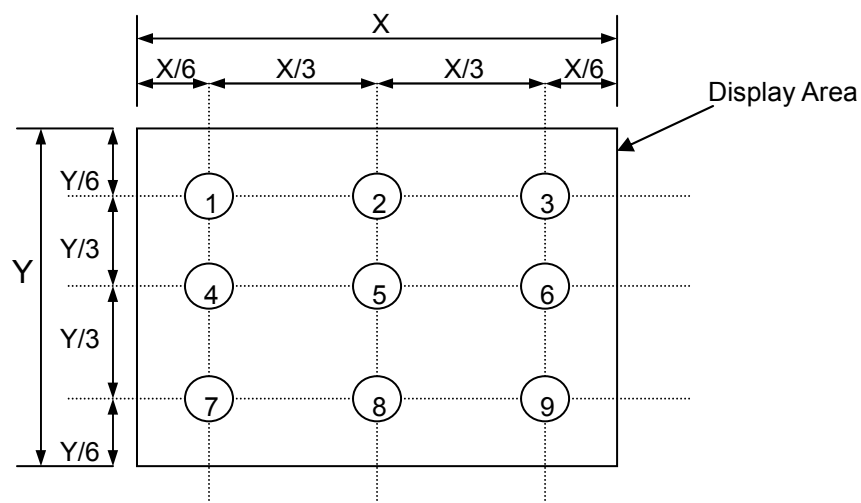

8. Block Diagram and Power Supply

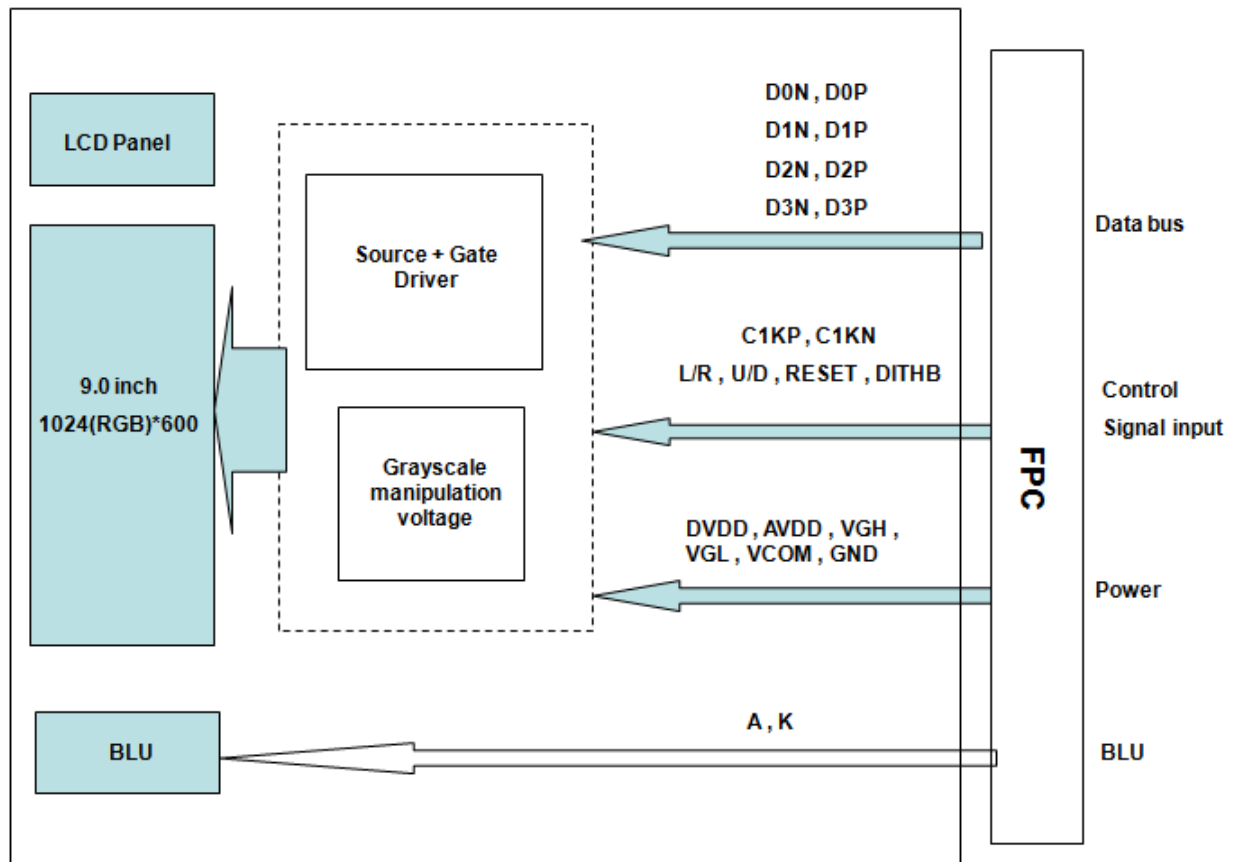

9. Interface Pins Definition

1) TFT pin

No.	Symbol	Function	Remark
1	VLED+	Not connected	
2	VLED+	Not connected	
3	VLED-	Not connected	
4	VLED-	Not connected	
5	GND	Ground	
6	VCOM	Common Voltage.	
7	DVDD	Power Supply	
8	GND	Ground	
9	D0N	-LVDS differential data input.	
10	D0P	+LVDS differential data input.	
11	GND	Ground	
12	D1N	-LVDS differential data input.	
13	D1P	+LVDS differential data input.	
14	GND	Ground	
15	D2N	-LVDS differential data input.	
16	D2P	+LVDS differential data input.	
17	GND	Ground	
18	C1KN	-LVDS differential clock input.	
19	C1KP	+LVDS differential clock input.	
20	GND	Ground	
21	D3N	-LVDS differential data input.	
22	D3P	+LVDS differential data input.	
23	GND	Ground	
24	NC	Not connected	
25	NC	Not connected	
26	NC	Not connected	
27	NC	Not connected	
28	GND	Ground	
29	L/R	Horizontal inversion. H: SO1→ SO2→ SO3→ . . . →SO1536. (Default) L: SO1536→ SO1535→ SO1534→ . . . →SO1.	
30	U/D	Vertical inversion. H, reverse scan. vertical start pulse and UD pin output "H" to Gate L, normal scan. (Default) vertical start pulse and UD pin output "L" to Gate	
31	VGH	Gate ON Voltage.	
32	VGL	Gate OFF Voltage.	
33	AVDD	Power for Analog Circuit	

34	RESET	Global reset pin	
35	NC	Not connected	
36	VCOM	Common Voltage.	
37	DITHB	"H": enable internal dithering function "L": disable internal dithering function	
38	GND	Ground	
39	NC	Not connected	
40	NC	Not connected	

2) Backlight pin

Connector: JST BHSR-02VS-01 or equivalent

No.	Symbol	Function	Remark
1	Red (A)	LED Anode.	
2	Black (K)	LED Cathode.	

10. AC characteristics

10.1.LVDS mode AC electrical characteristic

Parameter	Symbol	Min.	Typ.	Max.	Unit	Condition
Clock frequency	R_{xFCLK}	26.2		71	MHz	
Input data skew margin	T_{RSKM}	500			pS	$ V_{ID} = 400mV$ $R_{xVCM} = 1.2V$ $R_{xFCLK} = 71 MHz$
Clock high time	T_{LVCH}		$4/(7 * R_{xFCLK})$		ns	
Clock low time	T_{LVCL}		$3/(7 * R_{xFCLK})$		ns	
PLL wake-up time	T_{enPLL}			150	uS	

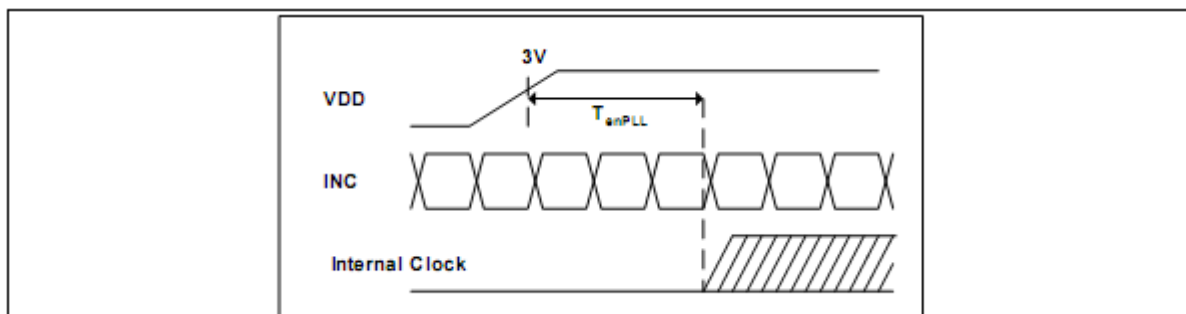
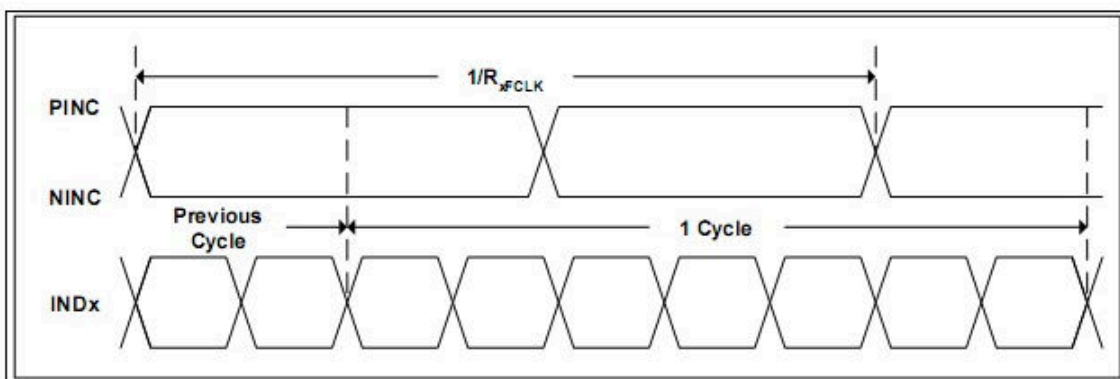

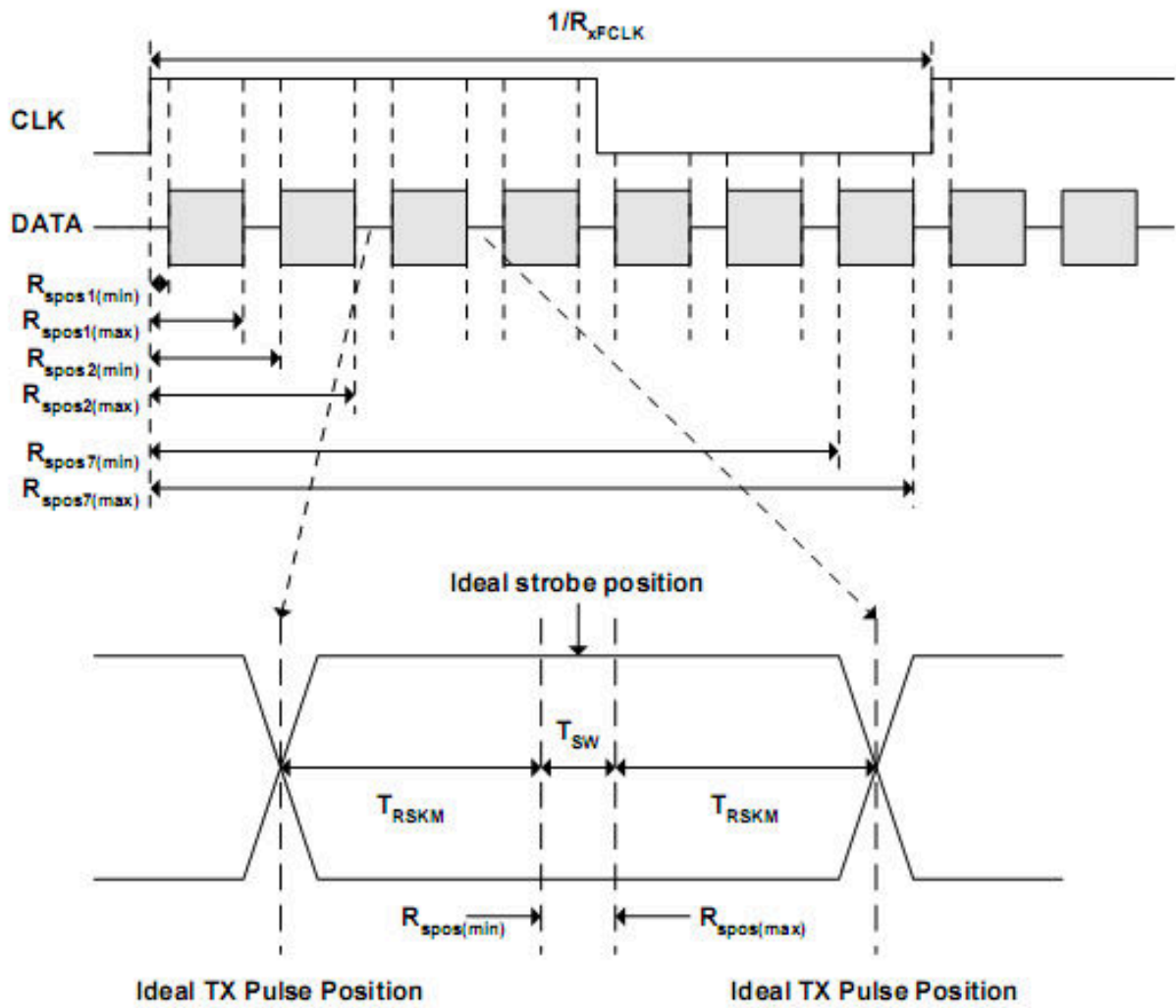

T_{RSKM} : Receiver strobe margin
 R_{SPOS} : Receiver strobe position
 T_{SW} : Strobe width (Internal data sampling window)

SSC tolerance of LVDS receiver						
Symbol	parameter	condition	Min.	Typ.	Max.	Units
SSCMF	Modulation Frequency		23		93	KHz
SSCMR	Modulation Rate	LVDS clock = 71MHz center spread			±3	%

10.2.Data Input Format for LVDS

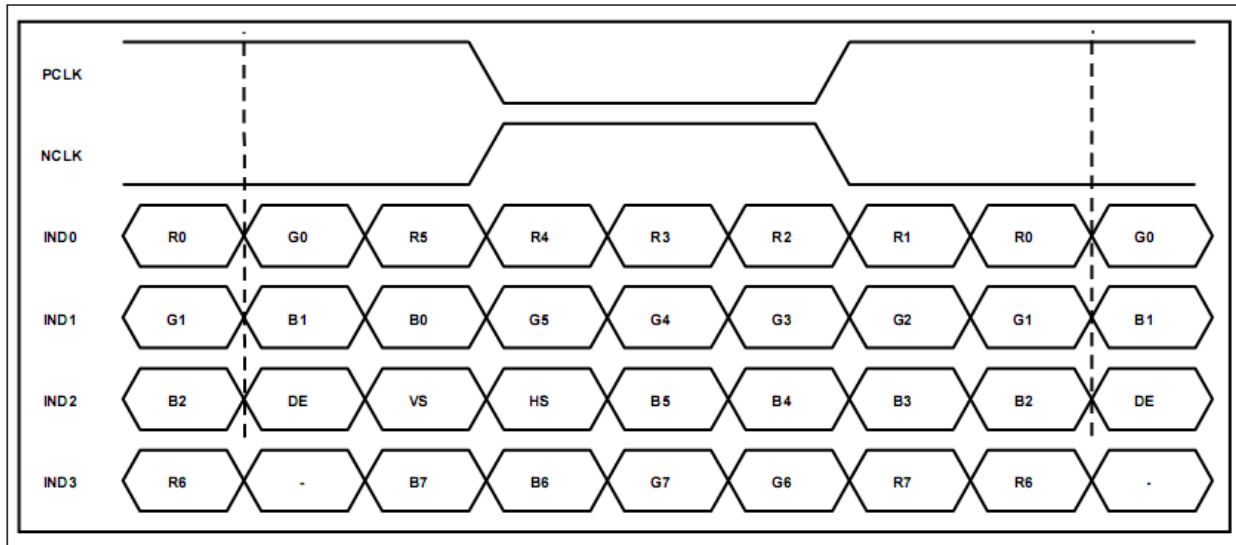

11. Quality Assurance

11.1 Purpose

This standard for Quality Assurance assures the quality of LCD module products supplied to customer.

11.2 Standard for Quality Test

11.2.1 Sampling Plan:

GB2828.1-2012

Single sampling, general inspection level II.

11.2.2 Sampling Criteria:

Visual inspection: AQL 1.5%

Electrical functional: AQL 0.65%.

11.2.3 Reliability Test:

Detailed requirement refer to Reliability Test Specification.

11.3 Nonconforming Analysis & Disposition

11.3.1 Nonconforming analysis:

11.3.1.1 Customer should provide overall information of non-conforming sample for their complaints.

11.3.1.2 After receipt of detailed information from customer, the analysis of nonconforming parts usually should be finished in one week.

11.3.1.3 If cannot finish the analysis on time, customer will be notified with the progress status.

11.3.2 Disposition of nonconforming:

11.3.2.1 Non-conforming product over PPM level will be replaced.

11.3.2.2 The cause of non-conformance will be analyzed. Corrective action will be discussed and implemented.

11.4 Agreement Items

Shall negotiate with customer if the following situation occurs:

11.4.1 There is any discrepancy in standard of quality assurance.

11.4.2 Additional requirement to be added in product specification.

11.4.3 Any other special problem.

11.5 Standard of the Product Visual Inspection

11.5.1 Appearance inspection:

11.5.1.1 The inspection must be under illumination about 1000 – 1500 lx, and the distance of view must be at 30cm ± 2cm.

11.5.1.2 The viewing angle should be 45° from the vertical line without reflection light or follows customer's viewing angle specifications.

11.5.1.3 Definition of area: A Zone: Active Area, B Zone: Viewing Area,

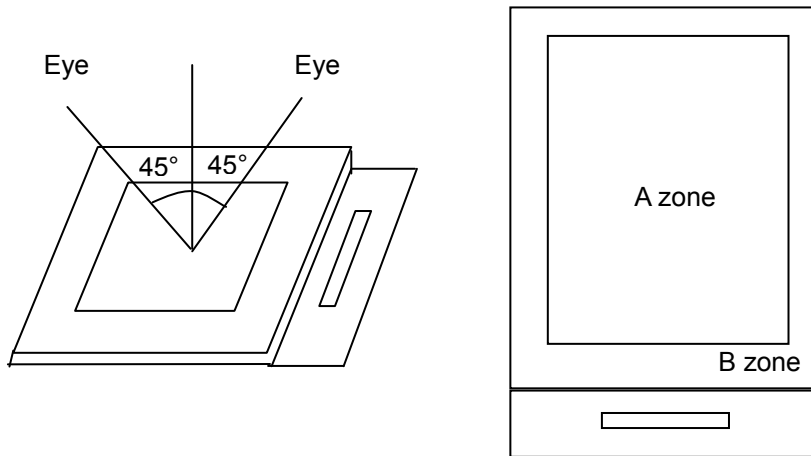

11.5.2 Basic principle:

11.5.2.1 A set of sample to indicate the limit of acceptable quality level must be discussed by both us and customer when there is any dispute happened.

11.5.2.2 New item must be added on time when it is necessary.

11.6 Inspection Specification for the TFT module

No.	Item	Criteria (Unit: mm)																		
01	Black / White spot Foreign material (Round type) Pinholes Stain Particles inside cell. (Minor defect)	<table border="1" style="margin-left: 20px;"> <thead> <tr> <th>Size</th> <th>Area</th> <th>Acc. Qty</th> </tr> </thead> <tbody> <tr> <td>$\phi \leq 0.20$</td> <td></td> <td>Ignore</td> </tr> <tr> <td>$0.20 < \phi \leq 0.50$</td> <td></td> <td>$N \leq 3$</td> </tr> <tr> <td>$0.50 < \phi$</td> <td></td> <td>0</td> </tr> </tbody> </table> <p>$\phi = (a + b) / 2$ Distance between 2 defects should more than 5mm apart.</p>	Size	Area	Acc. Qty	$\phi \leq 0.20$		Ignore	$0.20 < \phi \leq 0.50$		$N \leq 3$	$0.50 < \phi$		0						
Size	Area	Acc. Qty																		
$\phi \leq 0.20$		Ignore																		
$0.20 < \phi \leq 0.50$		$N \leq 3$																		
$0.50 < \phi$		0																		
02	Electrical Defect (Minor defect)	<table border="1" style="margin-left: 20px;"> <thead> <tr> <th></th> <th>Display Area</th> <th>Total</th> <th rowspan="3">Note1</th> </tr> </thead> <tbody> <tr> <td>Bright dot</td> <td>$N \leq 2$</td> <td>$N \leq 2$</td> </tr> <tr> <td>Dark dot</td> <td>$N \leq 4$</td> <td>$N \leq 4$</td> </tr> <tr> <td>Total dot</td> <td>$N \leq 4$</td> <td>$N \leq 4$</td> <td></td> </tr> <tr> <td>Mura</td> <td colspan="2">Not visible through 5% ND filters.</td> <td>Note 2</td> </tr> </tbody> </table> <p>Remark: 1. Bright dot caused by scratch and foreign object accords to item 1.</p>		Display Area	Total	Note1	Bright dot	$N \leq 2$	$N \leq 2$	Dark dot	$N \leq 4$	$N \leq 4$	Total dot	$N \leq 4$	$N \leq 4$		Mura	Not visible through 5% ND filters.		Note 2
	Display Area	Total	Note1																	
Bright dot	$N \leq 2$	$N \leq 2$																		
Dark dot	$N \leq 4$	$N \leq 4$																		
Total dot	$N \leq 4$	$N \leq 4$																		
Mura	Not visible through 5% ND filters.		Note 2																	

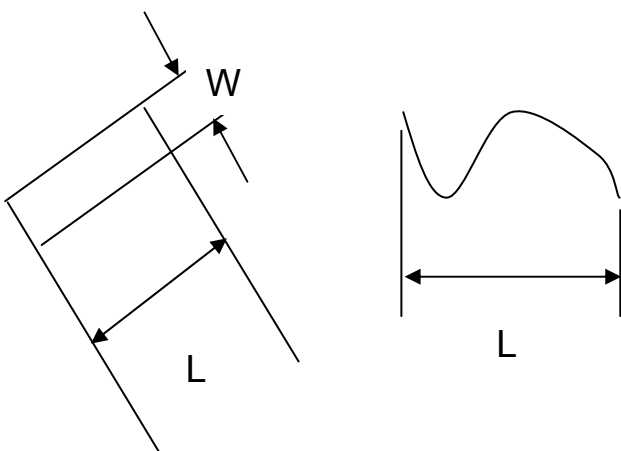
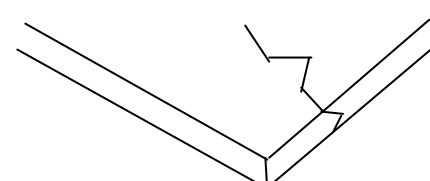
03	Black and White line Scratch Foreign material (Line type) (Minor defect)	 <table border="1" data-bbox="574 739 1197 1008"> <thead> <tr> <th>Length</th> <th>Width</th> <th>Acc. Qty</th> </tr> </thead> <tbody> <tr> <td>/</td> <td>$W \leq 0.1$</td> <td>Ignore</td> </tr> <tr> <td>$L \leq 2.5$</td> <td>$0.1 < W \leq 0.2$</td> <td>3</td> </tr> <tr> <td>$L > 2.5$</td> <td>$0.2 < W$</td> <td>0</td> </tr> <tr> <td colspan="2">Total</td> <td>3</td> </tr> </tbody> </table> <p data-bbox="510 1052 1404 1131">Distance between 2 defects should more than 3mm apart. Scratches not viewable through the back of the display are acceptable.</p>	Length	Width	Acc. Qty	/	$W \leq 0.1$	Ignore	$L \leq 2.5$	$0.1 < W \leq 0.2$	3	$L > 2.5$	$0.2 < W$	0	Total		3
Length	Width	Acc. Qty															
/	$W \leq 0.1$	Ignore															
$L \leq 2.5$	$0.1 < W \leq 0.2$	3															
$L > 2.5$	$0.2 < W$	0															
Total		3															
04	Glass Crack (Minor defect)	 <p data-bbox="510 1444 1149 1489">Crack is potential to enlarge, any type is not allowed.</p>															

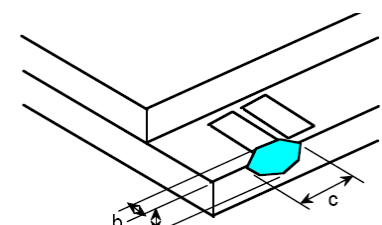
05	Glass Chipping Pad Area: (Minor defect)	 <table border="1" data-bbox="861 1724 1324 1892"> <thead> <tr> <th>Length and Width</th> <th>Acc. Qty</th> </tr> </thead> <tbody> <tr> <td>$c > 3.0, b < 1.0$</td> <td>1</td> </tr> <tr> <td>$c < 3.0, b < 1.0$</td> <td>3</td> </tr> <tr> <td colspan="2">$a < \text{Glass Thickness}$</td> </tr> </tbody> </table>	Length and Width	Acc. Qty	$c > 3.0, b < 1.0$	1	$c < 3.0, b < 1.0$	3	$a < \text{Glass Thickness}$	
Length and Width	Acc. Qty									
$c > 3.0, b < 1.0$	1									
$c < 3.0, b < 1.0$	3									
$a < \text{Glass Thickness}$										

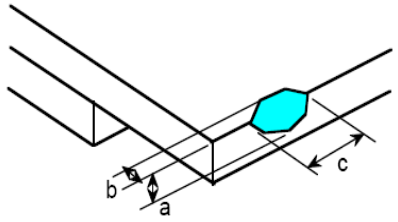
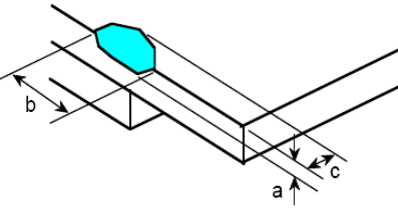
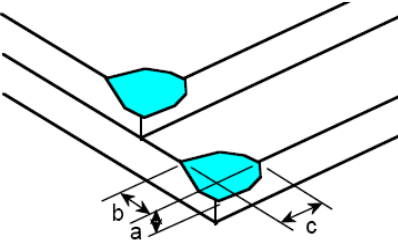
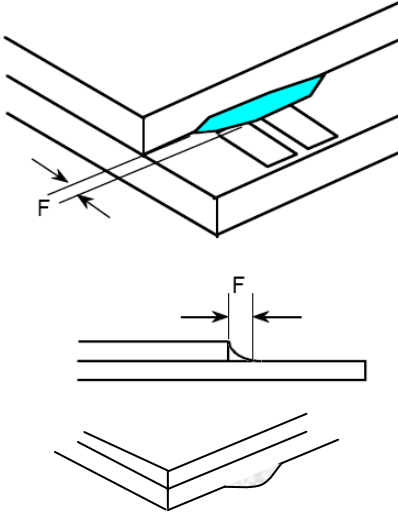
<p>06</p>	<p>Glass Chipping Rear of Pad Area: (Minor defect)</p> 	<table border="1"> <thead> <tr> <th>Length and Width</th> <th>Acc. Qty</th> </tr> </thead> <tbody> <tr> <td>$c > 3.0, b < 1.0$</td> <td>1</td> </tr> <tr> <td>$c < 3.0, b < 1.0$</td> <td>2</td> </tr> <tr> <td>$c < 3.0, b < 0.5$</td> <td>4</td> </tr> <tr> <td colspan="2" style="text-align: center;">$a < \text{Glass Thickness}$</td> </tr> </tbody> </table>	Length and Width	Acc. Qty	$c > 3.0, b < 1.0$	1	$c < 3.0, b < 1.0$	2	$c < 3.0, b < 0.5$	4	$a < \text{Glass Thickness}$	
Length and Width	Acc. Qty											
$c > 3.0, b < 1.0$	1											
$c < 3.0, b < 1.0$	2											
$c < 3.0, b < 0.5$	4											
$a < \text{Glass Thickness}$												
<p>07</p>	<p>Glass Chipping Except Pad Area: (Minor defect)</p> 	<table border="1"> <thead> <tr> <th>Length and Width</th> <th>Acc. Qty</th> </tr> </thead> <tbody> <tr> <td>$c > 3.0, b < 1.0$</td> <td>1</td> </tr> <tr> <td>$c < 3.0, b < 1.0$</td> <td>2</td> </tr> <tr> <td>$c < 3.0, b < 0.5$</td> <td>4</td> </tr> <tr> <td colspan="2" style="text-align: center;">$a < \text{Glass Thickness}$</td> </tr> </tbody> </table>	Length and Width	Acc. Qty	$c > 3.0, b < 1.0$	1	$c < 3.0, b < 1.0$	2	$c < 3.0, b < 0.5$	4	$a < \text{Glass Thickness}$	
Length and Width	Acc. Qty											
$c > 3.0, b < 1.0$	1											
$c < 3.0, b < 1.0$	2											
$c < 3.0, b < 0.5$	4											
$a < \text{Glass Thickness}$												
<p>08</p>	<p>Glass Corner Chipping: (Minor defect)</p> 	<table border="1"> <thead> <tr> <th>Length and Width</th> <th>Acc. Qty</th> </tr> </thead> <tbody> <tr> <td>$c < 3.0, b < 3.0$</td> <td>Ignore</td> </tr> <tr> <td colspan="2" style="text-align: center;">$a < \text{Glass Thickness}$</td> </tr> </tbody> </table>	Length and Width	Acc. Qty	$c < 3.0, b < 3.0$	Ignore	$a < \text{Glass Thickness}$					
Length and Width	Acc. Qty											
$c < 3.0, b < 3.0$	Ignore											
$a < \text{Glass Thickness}$												
<p>09</p>	<p>Glass Burr: (Minor defect)</p> 	<table border="1"> <thead> <tr> <th>Length</th> <th>Acc. Qty</th> </tr> </thead> <tbody> <tr> <td>$F < 1.0$</td> <td>Ignore</td> </tr> </tbody> </table> <p>Glass burr don't affect assemble and module dimension.</p>	Length	Acc. Qty	$F < 1.0$	Ignore						
Length	Acc. Qty											
$F < 1.0$	Ignore											

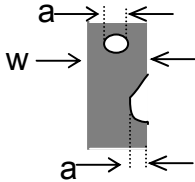
10	<p>FPC Defect: (Minor defect)</p> 	<p>10.1 Dent, pinhole width $a < w/3$. (w: circuitry width.) 10.2 Open circuit is unacceptable. 10.3 No oxidation, contamination and distortion.</p>								
11	Bubble on Polarizer (Minor defect)	<table border="1" data-bbox="737 593 1206 766"> <thead> <tr> <th>Diameter</th> <th>Acc. Qty</th> </tr> </thead> <tbody> <tr> <td>$\varphi \leq 0.30$</td> <td>Ignore</td> </tr> <tr> <td>$0.30 < \varphi \leq 0.50$</td> <td>$N \leq 2$</td> </tr> <tr> <td>$0.50 < \varphi$</td> <td>$N=0$</td> </tr> </tbody> </table>	Diameter	Acc. Qty	$\varphi \leq 0.30$	Ignore	$0.30 < \varphi \leq 0.50$	$N \leq 2$	$0.50 < \varphi$	$N=0$
Diameter	Acc. Qty									
$\varphi \leq 0.30$	Ignore									
$0.30 < \varphi \leq 0.50$	$N \leq 2$									
$0.50 < \varphi$	$N=0$									
12	Dent on Polarizer (Minor defect)	<table border="1" data-bbox="737 835 1206 1008"> <thead> <tr> <th>Diameter</th> <th>Acc. Qty</th> </tr> </thead> <tbody> <tr> <td>$\varphi \leq 0.25$</td> <td>Ignore</td> </tr> <tr> <td>$0.25 < \varphi \leq 0.50$</td> <td>$N \leq 4$</td> </tr> <tr> <td>$0.50 < \varphi$</td> <td>None</td> </tr> </tbody> </table>	Diameter	Acc. Qty	$\varphi \leq 0.25$	Ignore	$0.25 < \varphi \leq 0.50$	$N \leq 4$	$0.50 < \varphi$	None
Diameter	Acc. Qty									
$\varphi \leq 0.25$	Ignore									
$0.25 < \varphi \leq 0.50$	$N \leq 4$									
$0.50 < \varphi$	None									
13	Bezel	<p>13.1 No rust, distortion on the Bezel. 13.2 No visible fingerprints, stains or other contamination.</p>								
14	Touch Panel	<p>D: Diameter W: width L: length 14.1 Spot: $D < 0.25$ is acceptable $0.25 \leq D \leq 0.4$ 2dots are acceptable and the distance between defects should more than 10 mm. $D > 0.4$ is unacceptable 14.2 Dent: $D > 0.40$ is unacceptable 14.3 Scratch: $W \leq 0.03$, $L \leq 10$ is acceptable, $0.03 < W \leq 0.10$, $L \leq 10$ is acceptable Distance between 2 defects should more than 10 mm. $W > 0.10$ is unacceptable.</p>								
15	PCB	<p>15.1 No distortion or contamination on PCB terminals. 15.2 All components on PCB must same as documented on the BOM/component layout. 15.3 Follow IPC-A-600F.</p>								
16	Soldering	Follow IPC-A-610C standard								

17	Electrical Defect (Major defect)	<p>The below defects must be rejected.</p> <p>17.1 Missing vertical / horizontal segment, 17.2 Abnormal Display. 17.3 No function or no display. 17.4 Current exceeds product specifications. 17.5 LCD viewing angle defect. 17.6 No Backlight. 17.7 Dark Backlight. 17.8 Touch Panel no function.</p>
----	-------------------------------------	--

Remark: LCD Panel Broken shall be rejected. Defect out of LCD viewing area is acceptable.

11.8 Classification of Defects

11.8.1 Visual defects (Except no / wrong label) are treated as minor defect and electrical defect is major.

11.8.2 Two minor defects are equal to one major in lot sampling inspection.

11.9 Identification/marketing criteria

Any unit with illegible / wrong /double or no marking/ label shall be rejected.

11.10 Packaging

11.10.1 There should be no damage of the outside carton box, each packaging box should have one identical label.

11.10.2 Modules inside package box should have compliant mark.

11.10.3 All direct package materials shall offer ESD protection

Note1: Bright dot is defined as the defective area of the dot is larger than 50% of one sub-pixel area.

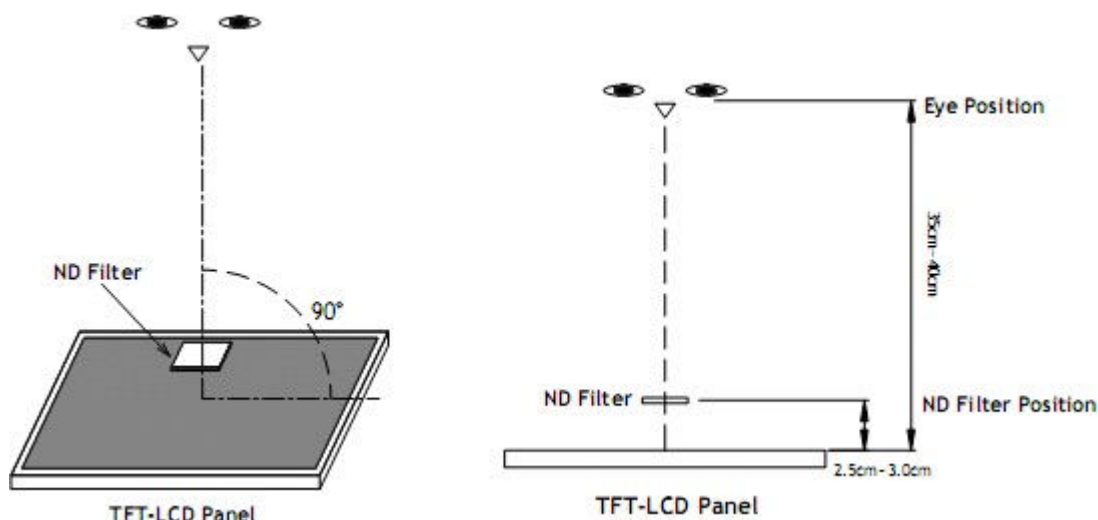

Bright dot: The bright dot size defect at black display pattern. It can be recognized by 2% transparency of filter when the distance between eyes and panel is $350\text{mm} \pm 50\text{mm}$.

Dark dot: Cyan, Magenta or Yellow dot size defect at white display pattern. It can be recognized by 5% transparency of filter when the distance between eyes and panel is $350\text{mm} \pm 50\text{mm}$.

Note2: Mura on display which appears darker / brighter against background brightness on parts of display area.

12. Reliability Specification

No	Item	Condition	Quantity	Criteria
1	High Temperature Operating	70°C, 96Hrs	2	GB/T2423.2-2008
2	Low Temperature Operating	-20°C, 96Hrs	2	GB/T2423.1-2008
3	High Humidity	50°C, 90%RH, 96Hrs	2	GB/T2423.3-2006
4	High Temperature Storage	80°C, 96Hrs	2	GB/T2423.2-2008
5	Low Temperature Storage	-30°C, 96Hrs	2	GB/T2423.1-2008
6	Thermal Cycling Test	-20°C, 60min ~ 70°C, 60min, 20 cycles.	2	GB/T2423.22-2012
7	Packing vibration	Frequency range:10Hz~50Hz Acceleration of gravity:5G X, Y, Z 30 min for each direction.	2	GB/T5170.14-2009
8	Drop Test (Packaged)	Height:72cm(weight ≤ 10kg),60cm (weight > 10kg) 1 corner, 3 edges, 6 surfaces.	2	GB/T2423.8-1995

Note1. No deflection cosmetic and operational function allowable.

Note2. Total current Consumption should be below double of initial value

13. Precautions and Warranty

13.1.Safety

- 13.1.1. The liquid crystal in the LCD is poisonous. Do not put it in your mouth. If the liquid crystal touches your skin or clothes, wash it off immediately using soap and water.
- 13.1.2. Since the liquid crystal cells are made of glass, do not apply strong impact on them. Handle with care.

13.2.Handling

- 13.2.1. Reverse and use within ratings in order to keep performance and prevent damage.
- 13.2.2. Do not wipe the polarizer with dry cloth, as it might cause scratch. If the surface of the LCD needs to be cleaned, wipe it swiftly with cotton or other soft cloth soaked with petroleum IPA, do not use other chemicals.

13.3.Storage

- 13.3.1. Do not store the LCD module beyond the specified temperature ranges.
- 13.3.2. Strong light exposure causes degradation of polarizer and color filter

13.4.Metal Pin (Apply to Products with Metal Pins)

13.4.1 Pins of LCD and Backlight

- 13.4.1.1 Solder tip can touch and press on the tip of Pin LEAD during the soldering

- 13.4.1.2 Recommended Soldering Conditions

Solder Type: Sn96.3~94-Ag3.3~4.3-Cu0.4~1.1

Maximum Solder Temperature: 370℃

Maximum Solder Time: 3s at the maximum temperature

Recommended Soldering Temp: 350±20℃

Typical Soldering Time: ≤3s

- 13.4.1.3 Solder Wetting

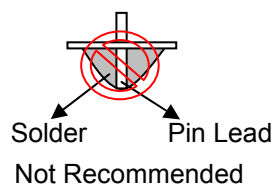
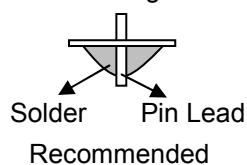

13.4.2 Pins of EL

- 13.4.2.1 Solder tip can touch and press on the tip of EL leads during soldering.

- 13.4.2.2 No Solder Paste on the soldering pad on the motherboard is recommended.

- 13.4.2.3 Recommended Soldering Conditions

Solder type: Nippon Alimit Leadfree SR-34, size 0.5mm

Recommended Solder Temperature: 270~290℃

Typical Soldering Time: ≤2s

Minimum solder distance from EL lamp (body):2.0mm

- 13.4.2.4 No horizontal press on the EL leads during soldering.

- 13.4.2.5 180° bend EL leads three times is not allowed.

13.4.2.6 Solder Wetting

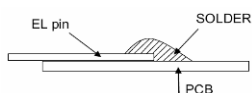

Recommended



Not Recommended

13.4.2.7 The type of the solder iron:

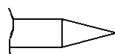

Recommended

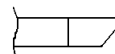

Not Recommended

13.4.2.8 Solder Pad

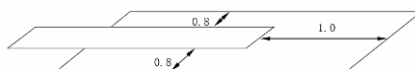

13.5.Operation

- 13.5.1. Do not drive LCD with DC voltage
- 13.5.2. Response time will increase below lower temperature
- 13.5.3. Display may change color with different temperature
- 13.5.4. Mechanical disturbance during operation, such as pressing on the display area, may cause the segments to appear "fractured".
- 13.5.5. Do not connect or disconnect the LCM to or from the system when power is on.
- 13.5.6. Never use the LCM under abnormal condition of high temperature and high humidity.
- 13.5.7. Module has high frequency circuits. Sufficient suppression to the electromagnetic interface shall be done by system manufacturers. Grounding and shielding methods may be important to minimize the interference.
- 13.5.8. Do not display the fixed pattern for long time (we suggest the time not longer than one hour) because it may develop image sticking due to the TFT structure.

13.6.Static Electricity

- 13.6.1. CMOS LSIs are equipped in this unit, so care must be taken to avoid the electro-static charge, by ground human body, etc.
- 13.6.2. The normal static prevention measures should be observed for work clothes and benches.
- 13.6.3. The module should be kept into anti-static bags or other containers resistant to static for storage.

13.7.Limited Warranty

- 13.7.1. Our warranty liability is limited to repair and/or replacement. We will not be responsible for any consequential loss.
- 13.7.2. If possible, we suggest customer to use up all modules in six months. If the module storage time over twelve months, we suggest that recheck it before the module be used.
- 13.7.3. After the product shipped, any product quality issues must be feedback within three months, otherwise, we will not be responsible for the subsequent or consequential events.

14. Packaging

TBD

QP-001-027

25/25

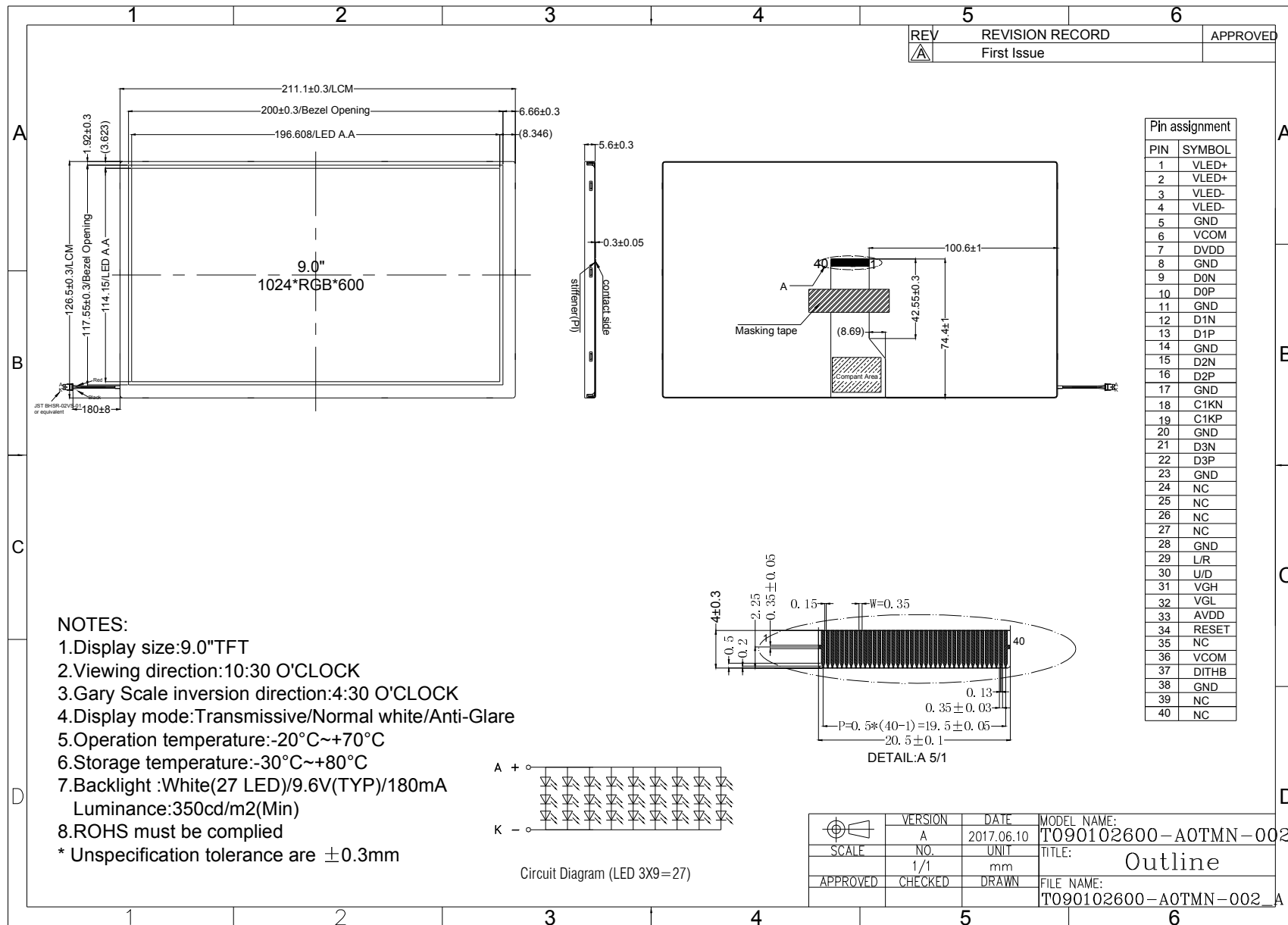

15. Outline Drawing

T090102600-A0TMN-002
 Rev: 1.1